

AluDoors

Aluminium panels
Ante in alluminio

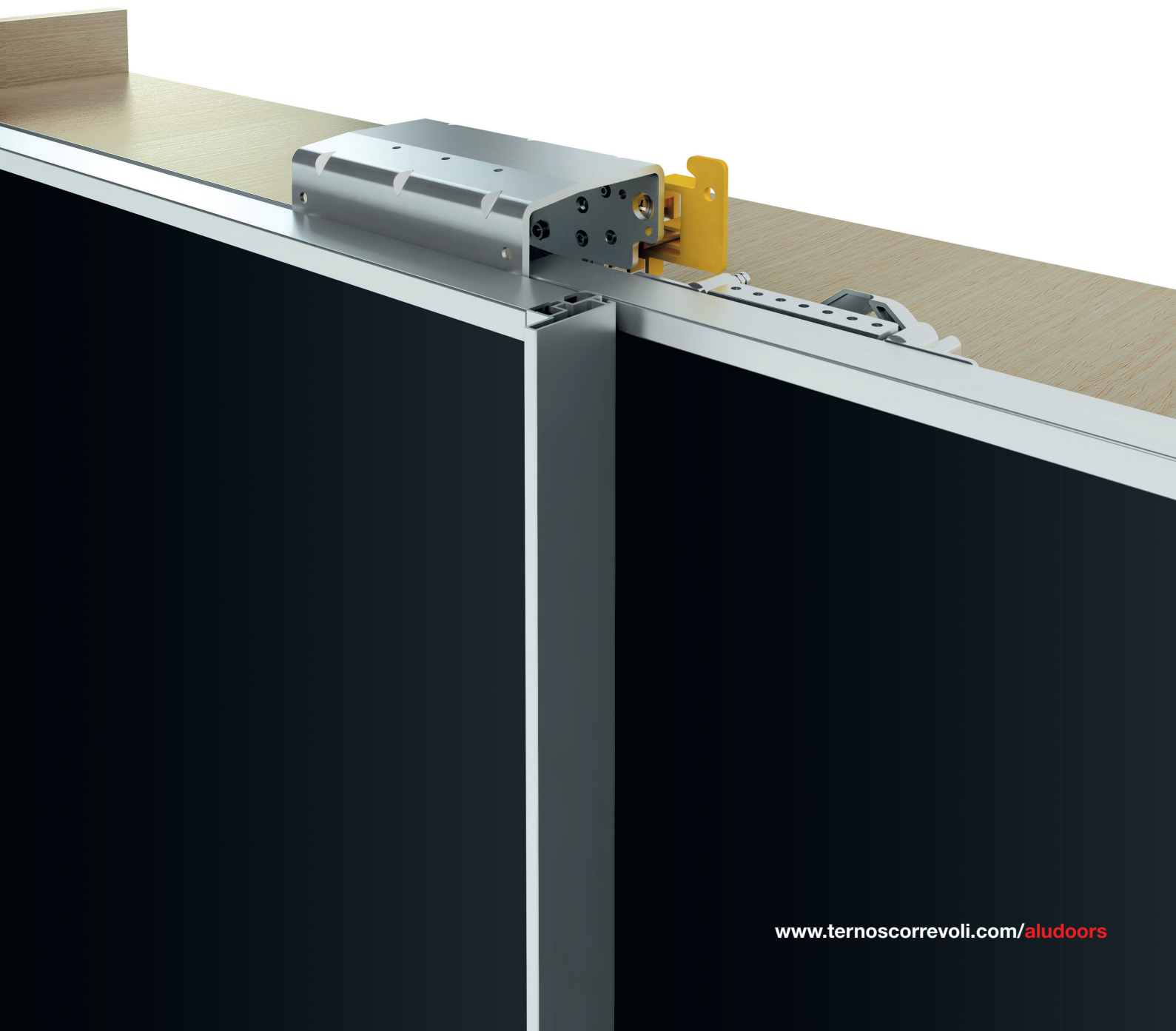

AluDoors

Aluminium sheets for sliding door panels.

Telai in alluminio per ante scorrevoli.





AluDoors is an aluminium frame designed for wardrobes doors, compatible to **Base**, **Star** and **Comfort** sliding systems and to related kits for 28 mm thickness.

The 90° cutting of profiles and special junctions allow the installation of AluDoors to be extremely easy, granting a final result marked by a **clean and linear design**.

AluDoors is available in different finishes.

AluDoors è un telaio in alluminio per ante di armadi compatibile con i sistemi scorrevoli **Base**, **Star** e **Comfort**, per ante con spessore da 28 mm.

Il taglio dei profili a 90° e le speciali giunzioni rendono l'installazione del telaio AluDoors particolarmente semplice e garantiscono un risultato dal **design pulito e lineare**.

AluDoors è disponibile in diverse finiture.

AluDoors		COMPLETE BOX KIT / KIT COMPLETO IN SCATOLA		
K	Complete kit / Kit completo			
		1061	N.1 aluminum door with 90° cut N.1 anta in alluminio con taglio a 90°	
		2	N.4 junctions and N.2 guiding connectors N.4 giunzioni e N.2 attacchi guide	

EXAMPLE / ESEMPIO

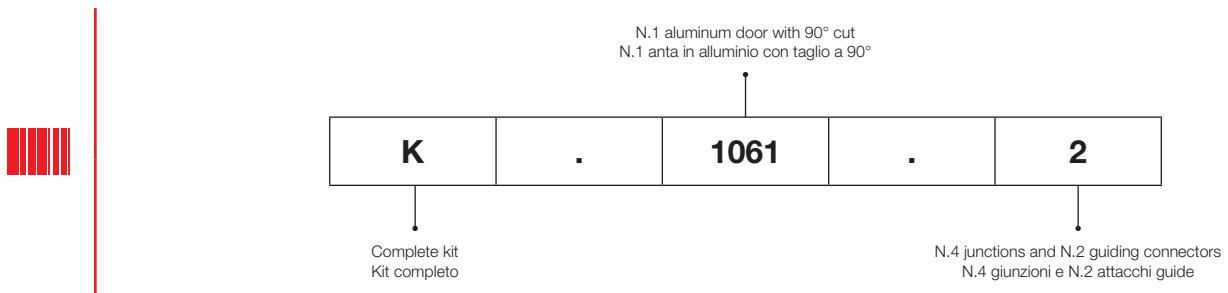

Tracks / Binari		ALUMINUM FINISHES CODES / CODICI FINITURE ALLUMINIO		
CODE / CODICE	FINISH COLOR / COLORE FINITURA			
8 02 0.0	02 AS	Brushed Anodized Silver / Argento Spazzolato	STANDARD	

Tracks / Binari		PLASTIC FINISHES CODES / CODICI FINITURE PLASTICA		
CODE / CODICE	FINISH COLOR / COLORE FINITURA			
8 23 0.0	23 GR	Gray / Grigio	STANDARD	

ADJUSTABLE SLIDES FOR DOOR WITH MAXIMUM THICKNESS OF 28 mm SCORREVOLI REGOLABILI PER ANTE SPESSORE MAX 28 mm

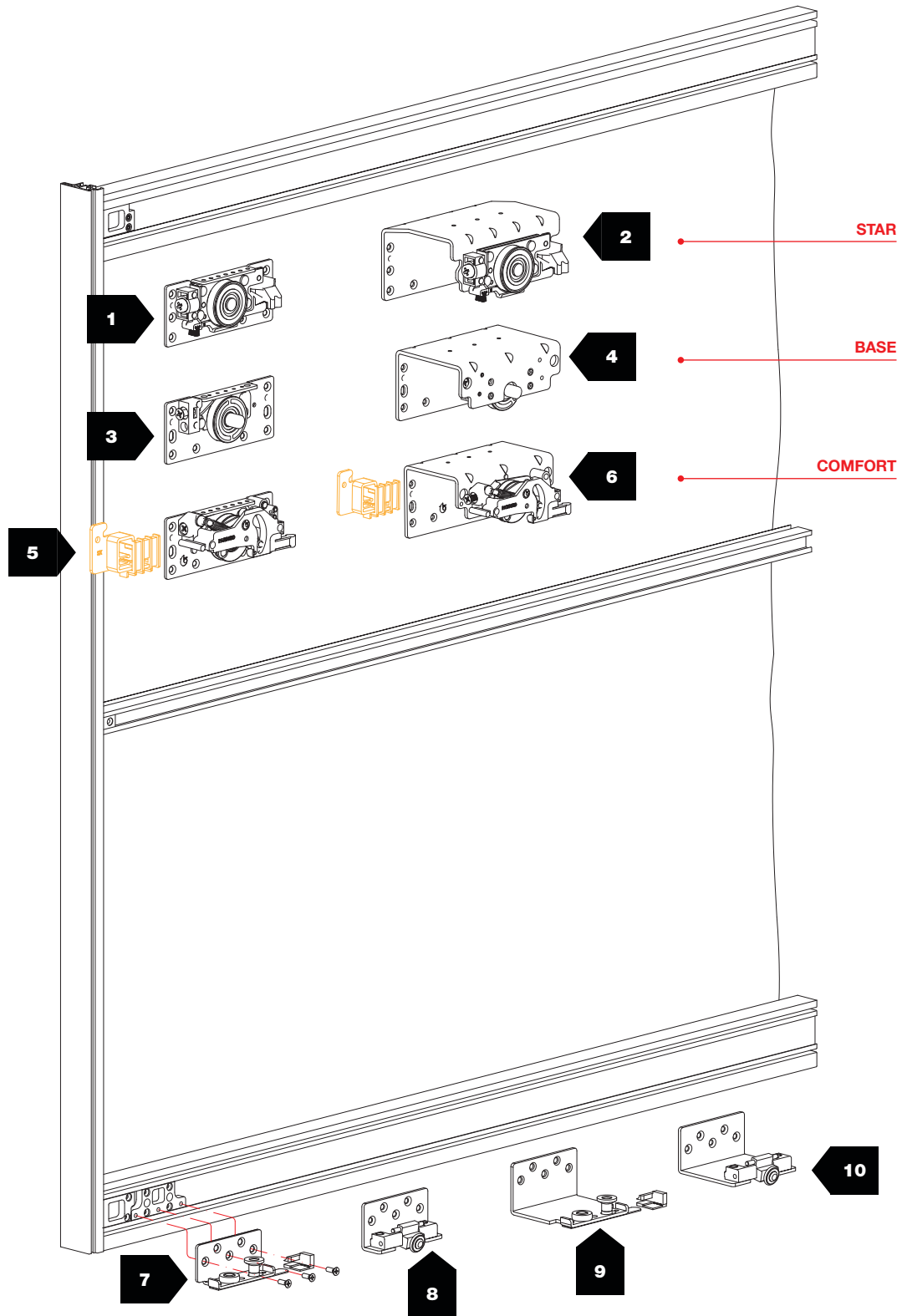

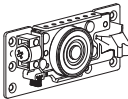
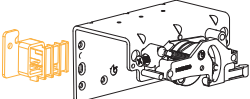
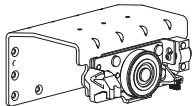
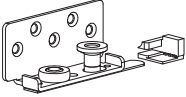
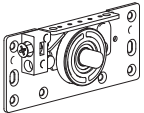
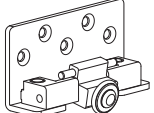
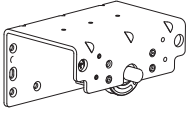
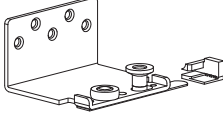
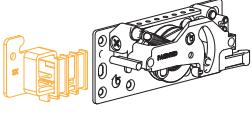
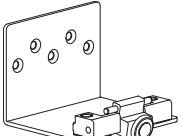
N°			kg	→ ←	N°			kg	→ ←
1	2102		—	28 mm	6	2966		—	28 mm
2	2105		—	28 mm	7	582		—	28 mm
3	2541		—	28 mm	8	1902/N		—	28 mm
4	2543		—	28 mm	9	586		—	28 mm
5	2961		—	28 mm	10	1906/N		—	28 mm

NOTE

The Squadro model aluminum frame can be used with tracks of the **COMFORT**, **STAR** and **BASE** systems from 28 mm.

Il telaio in alluminio modello Squadro può essere utilizzato con gli scorrevoli dei sistemi **COMFORT**, **STAR** e **BASE** da 28 mm.

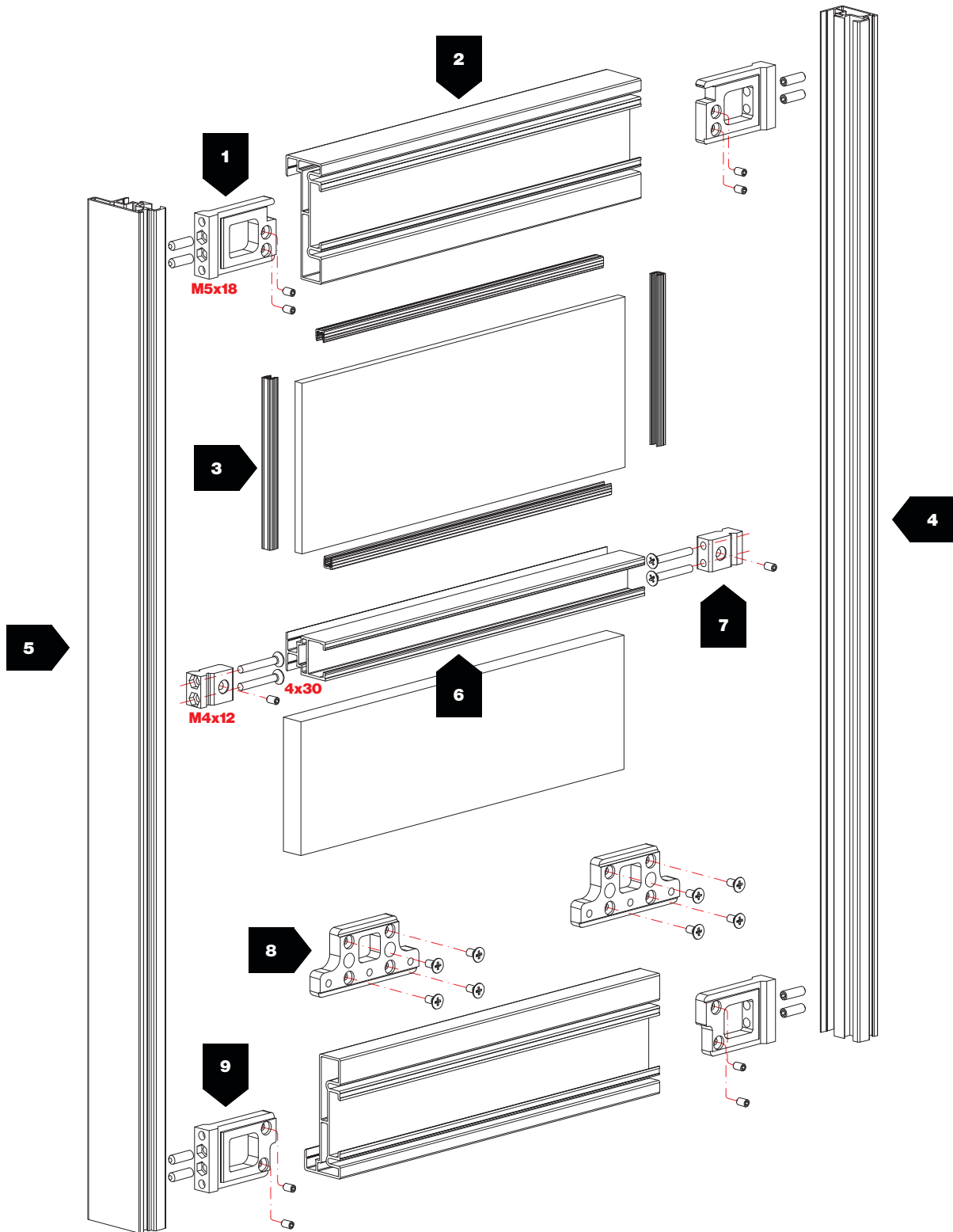

SQUADRO DOOR ACCESSORIES ACCESSORI ANTA SQUADRO



Max 28 mm

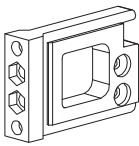

35 mm

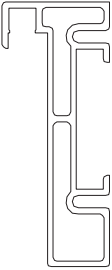
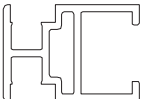
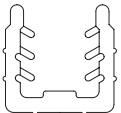
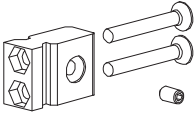
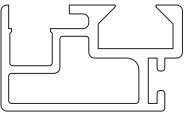
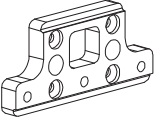
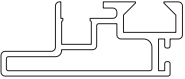
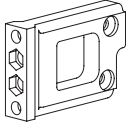
N°			kg		N°			kg	
1	1452		-		5	1464 8 02 0.01464		-	
2	1440 8 02 0.01440		-		6	1448 8 02 0.01448		-	OPTIONAL +
3	445/BG 8 23 0.00445		-		7	1454		-	OPTIONAL +
4	1462 8 02 0.01462		-		8	1453		-	
5	1460 8 02 0.01460		-		9	1451		-	

 Kit for N.1 door
Kit per N.1 anta

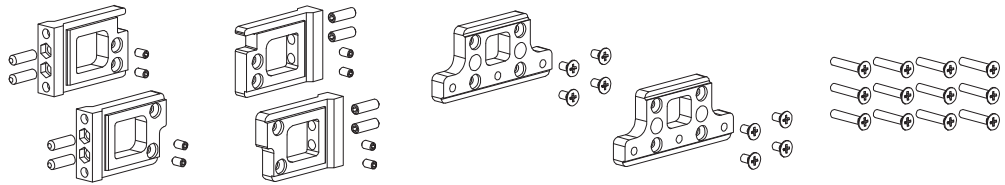

Aluminium shutters with a cut at 90° suitable for the insertion of windows and wood panels.
Ante in alluminio con taglio a 90° adatte per l'inserimento di vetri o pannelli in legno.

OLD CODE	NEW CODE	 	
1455 KIT	K.1061.2	28 mm	20x

MEASUREMENTS DESCRIPTION / DESCRIZIONE MISURE

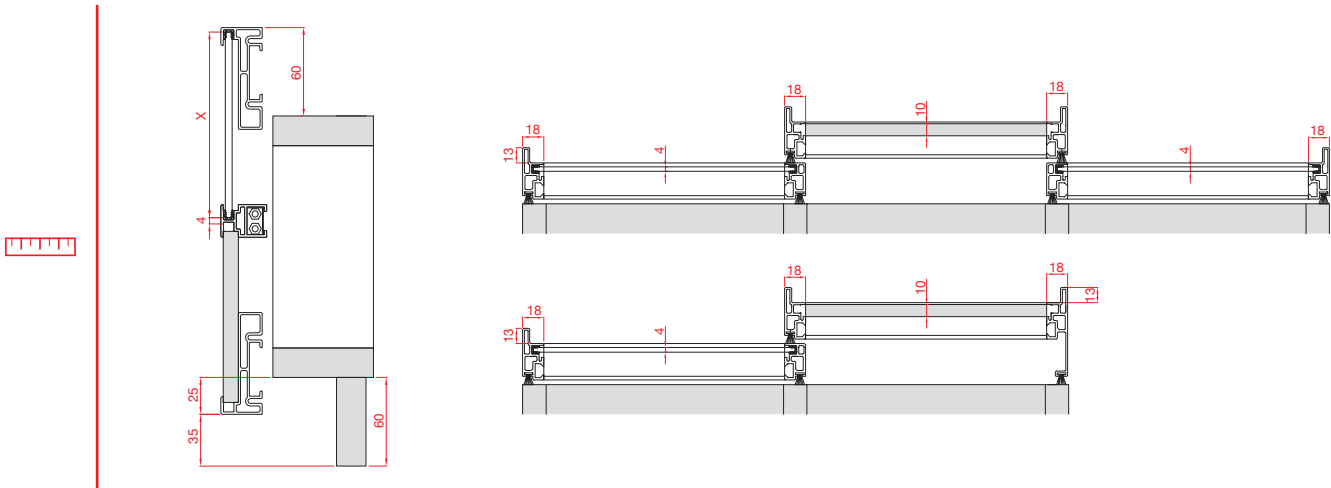

MEASUREMENTS DESCRIPTION / DESCRIZIONE MISURE

