



Sistemi di maniglie in alluminio per mobili.

System of furniture handles in aluminium.

Systèmes de poignées en aluminium pour meubles.

Türgriffsysteme aus Aluminium für Einrichtungsgegenstände.

Sistemas de manijas de aluminio para muebles.



Sistemi di maniglie in alluminio con possibilità di inserimento del vetro e dello spazzolino.

System of aluminium handles with possible glass inserts and brushes.

Systèmes de poignées en aluminium avec possibilité d'insertion du verre ou de la brosse.

Türgriffsysteme aus Aluminium mit der Möglichkeit eines Glas- oder Bürsteneinsatzes.

Systemas de manijas de aluminio con posibilidad de inserción del vidrio y del cepillo.

Package of handles for panel max. 18-19mm  
 Kit poignées pour panneau max. 18-19mm  
 Türgriff-Set für Panel max. 18-19mm  
 Confección manijas para panel máx. 18-19mm

**ART.2202**

Maniglia per pannello  
max 18-19mm  
con spazzolino

Handle for panel max.  
18-19mm  
whit dust brush

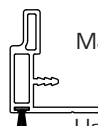

**ART.2200**

Contromaniglia  
per pannello  
max 18-19mm  
con spazzolino

Opposite handle  
for panel  
max 18-19mm  
whit dust brush



**ART.2204**

Maniglia lunga  
per pannello  
max 18-19mm  
con spazzolino

Long handle  
for panel  
max. 18-19mm  
whit dust brush

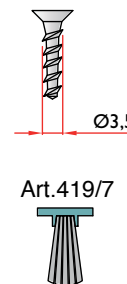
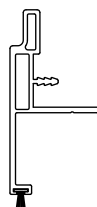

Utilizzare viti per  
legno Ø3,5  
Use Ø3.5 wood  
screws

Spazzolino  
antipolvere  
H=7mm  
base 5mm

Anti dust brush  
thickness  
H=7mm  
base 5mm

**ART.2202/A/2/2800/FS**

N°2 Art.2202  
forato con spazzolino  
drilled with dust brush

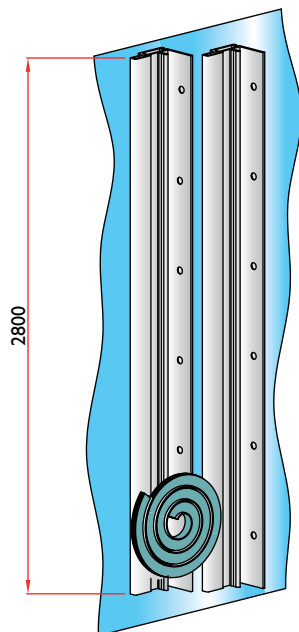

**KIT A**

**ART.2200/A/2/2800/FS**

N°2 Art.2200  
forato con spazzolino  
drilled with dust brush

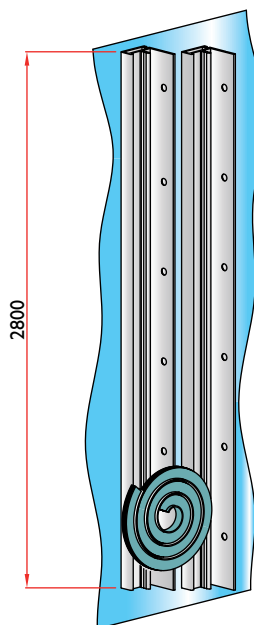

**KIT B**

**ART.2200/2204/A/2800/FS**

N°1 Art.2200 , N°1 Art.2204  
forato con spazzolino  
drilled with dust brush

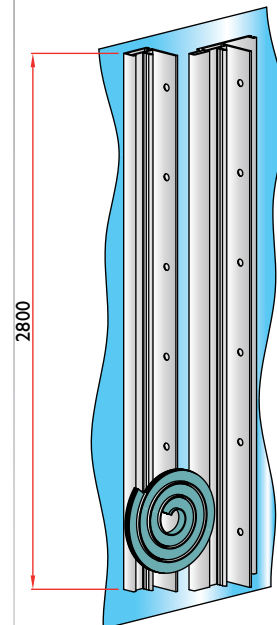

**KIT C**

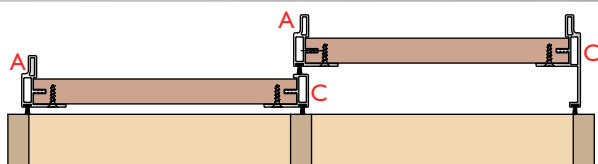

N°1 KIT A + N°1 KIT C

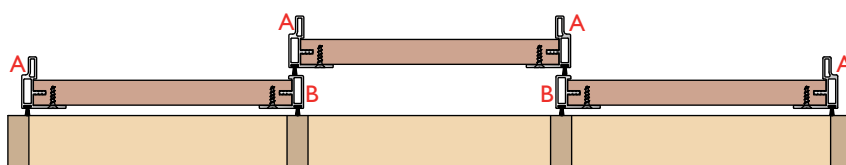

N°2 KIT A + N°1 KIT B

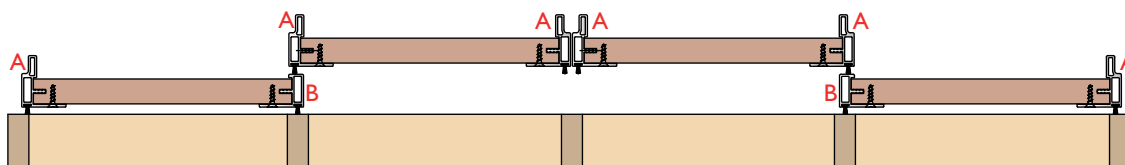

N°3 KIT A + N°1 KIT B

**Maniglie per pannelli spessore  
max. 18-19 mm**



Handle for panel max. 18-19mm  
Poignée pour panneau max. 18-19mm  
Griff für Panel max. 18-19mm  
Manijas para panel máx. 18-19mm

UTILIZZARE CON KIT SCORREVOLI DA 22MM  
USE WITH 22MM SLIDER KIT

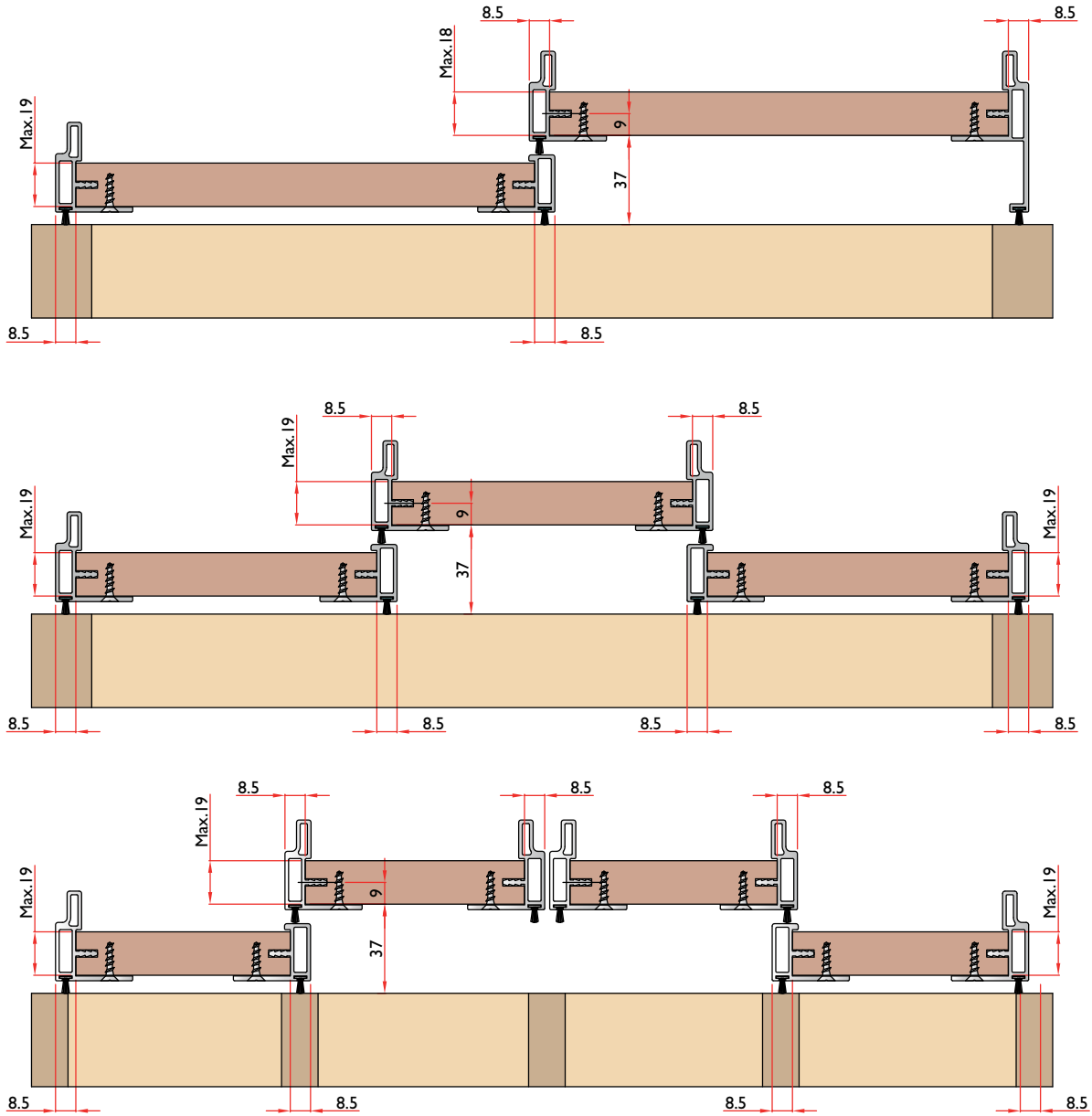

**ART.2200**

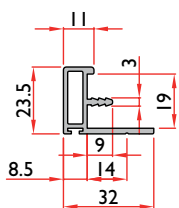

**ART.2202**

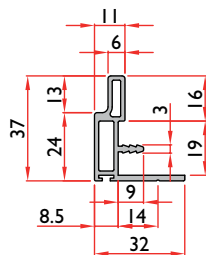

**ART.2204**

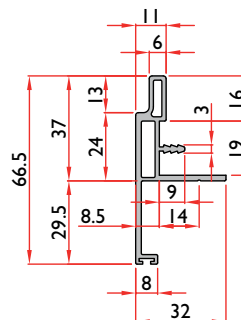

**ART.419**

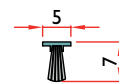

# Confezione maniglioni per pannelli spessore max.22-23 mm



Package of handles for panel max. 22-23mm  
 Kit poignées pour panneau max. 22-23mm  
 Türgriff-Set für Panel max. 22-23mm  
 Confección manijas para panel máx. 22-23mm

## ART.2212

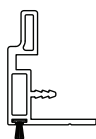

Maniglia per pannello max 22-23mm con spazzolino  
 Handle for panel max. 22-23mm whit dust brush

## ART.2210

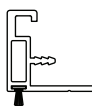

Contromaniglia per pannello max 22-23mm con spazzolino  
 Opposite handle for panel max 22-23mm whit dust brush

## ART.2214

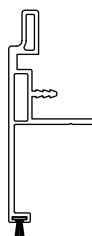

Maniglia lunga per pannello max 22-23mm con spazzolino  
 Long handle for panel max. 22-23mm whit dust brush

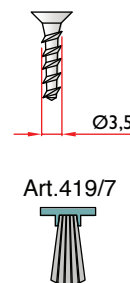

Utilizzare viti per legno Ø3,5  
 Use Ø3.5 wood screws  
 Spazzolino antipolvere H=7mm base 5mm  
 Anti dust brush thickness H=7mm base 5mm

### ART.2212/A/2/2800/FS

N°2 Art.2212 forato con spazzolino drilled with dust brush

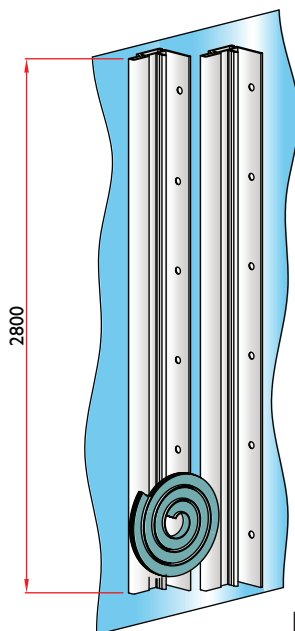

KIT A

### ART.2210/A/2/2800/FS

N°2 Art.2210 forato con spazzolino drilled with dust brush

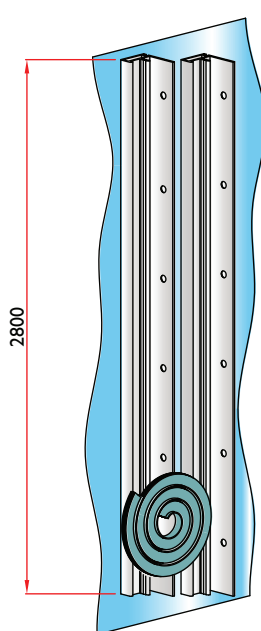

KIT B

### ART.2210/2214/A/2800/FS

N°1 Art.2210, N°1 Art.2214 forato con spazzolino drilled with dust brush

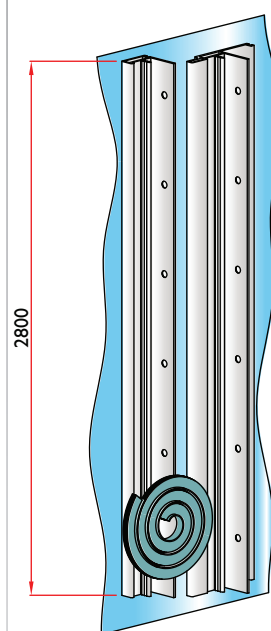

KIT C

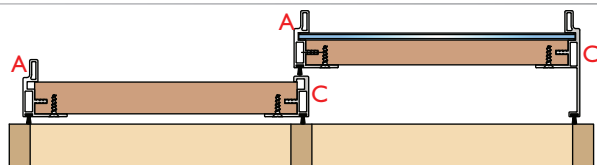

N°1 KIT A + N°1 KIT C



N°2 KIT A + N°1 KIT B

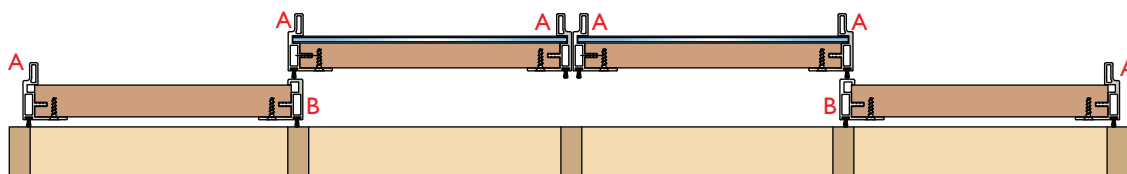

N°3 KIT A + N°1 KIT B



**Maniglie per pannelli spessore  
max.22-23 mm**



Handle for panel max.22-23mm  
Poignée pour panneau max. 22-23mm  
Griff für Panel max. 22-23mm  
Manijas para panel máx. 22-23mm

UTILIZZARE CON KIT SCORREVOLI DA 28MM  
USE WITH 28MM SLIDER KIT

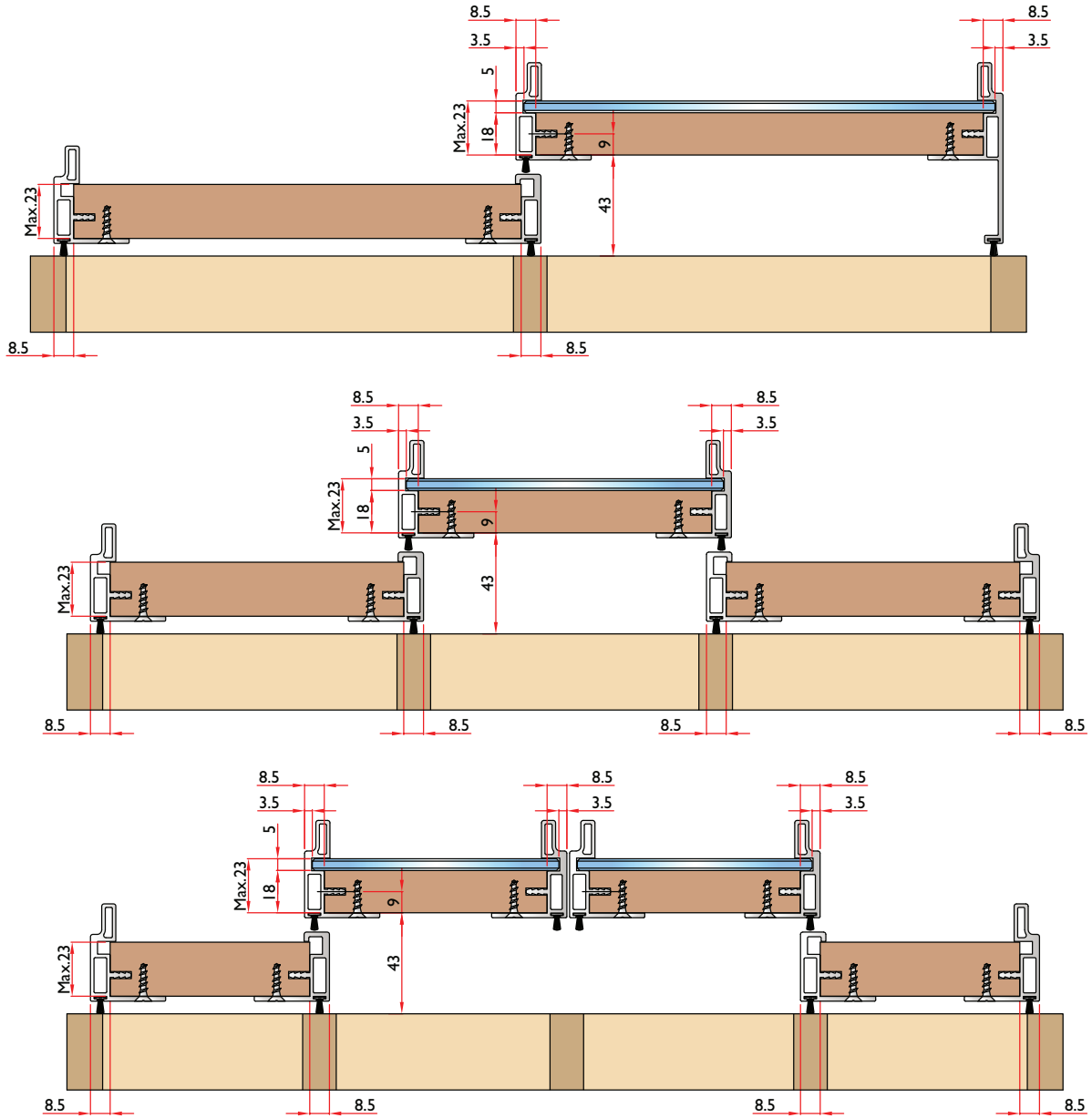

**ART.2210**

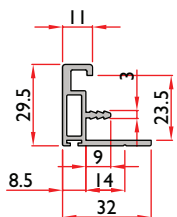

**ART.2212**

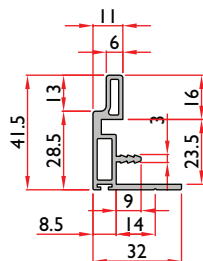

**ART.2214**

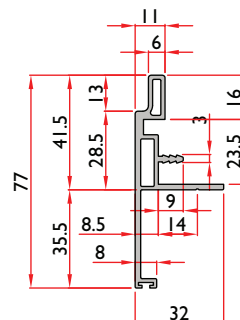

**ART.419**

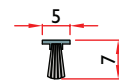

Package of handles for panel max. 25-26mm  
 Kit poignées pour panneau max. 25-26mm  
 Türgriff-Set für Panel max. 25-26mm  
 Confección manijas para panel máx. 25-26mm

**ART.2222**

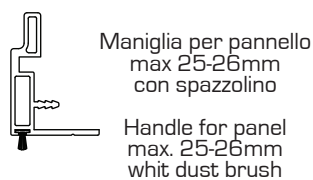

**ART.2220**

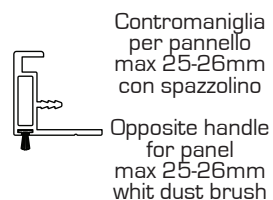

**ART.2224**

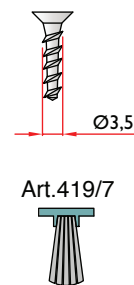
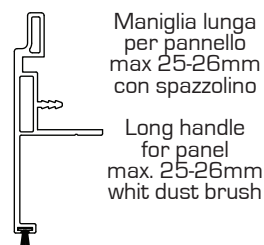

Utilizzare viti per  
legno Ø3,5  
Use Ø3.5 wood  
screws

Spazzolino  
antipolvere  
H=7mm  
base 5mm

Anti dust brush  
thickness  
H=7mm  
base 5mm

**ART.2222/A/2/2800/FS**

N°2 Art.2222  
forato con spazzolino  
drilled with dust brush

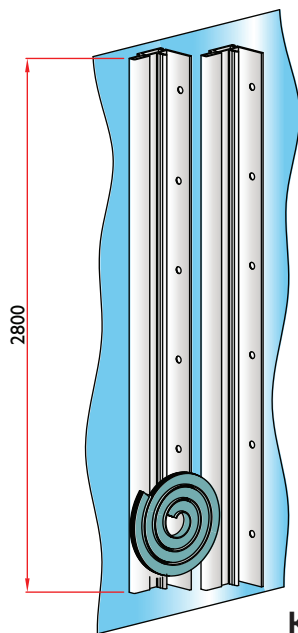

**ART.2220/A/2/2800/FS**

N°2 Art.2220  
forato con spazzolino  
drilled with dust brush

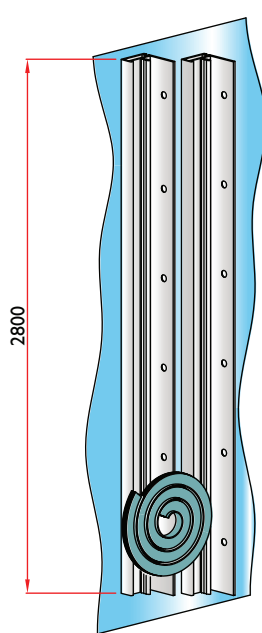

**ART.2220/2224/A/2800/FS**

N°1 Art.2220 , N°1 Art.2224  
forato con spazzolino  
drilled with dust brush

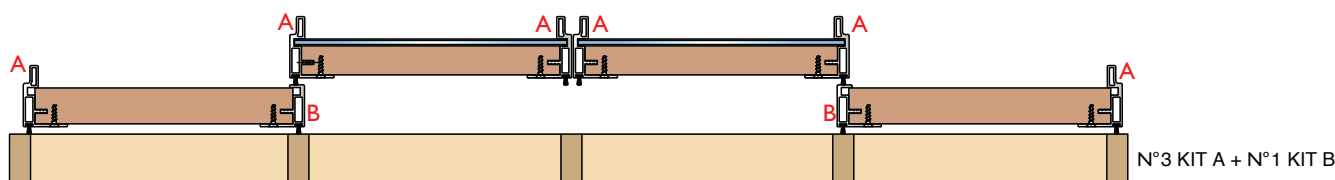
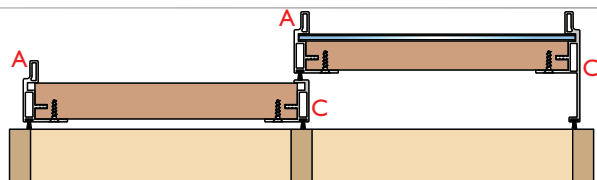
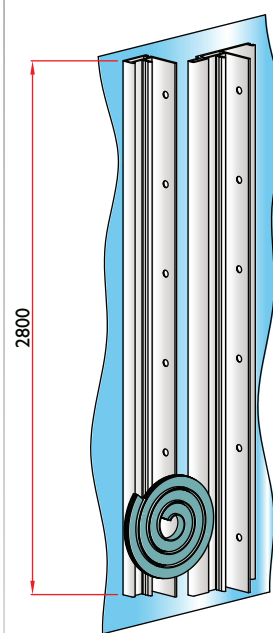

Handle for panel max. 25-26mm  
Poignée pour panneau max. 25-26mm  
Griff für Panel max. 25-26mm  
Manijas para panel máx. 25-26mm

UTILIZZARE CON KIT SCORREVOLI DA 28MM  
USE WITH 28MM SLIDER KIT

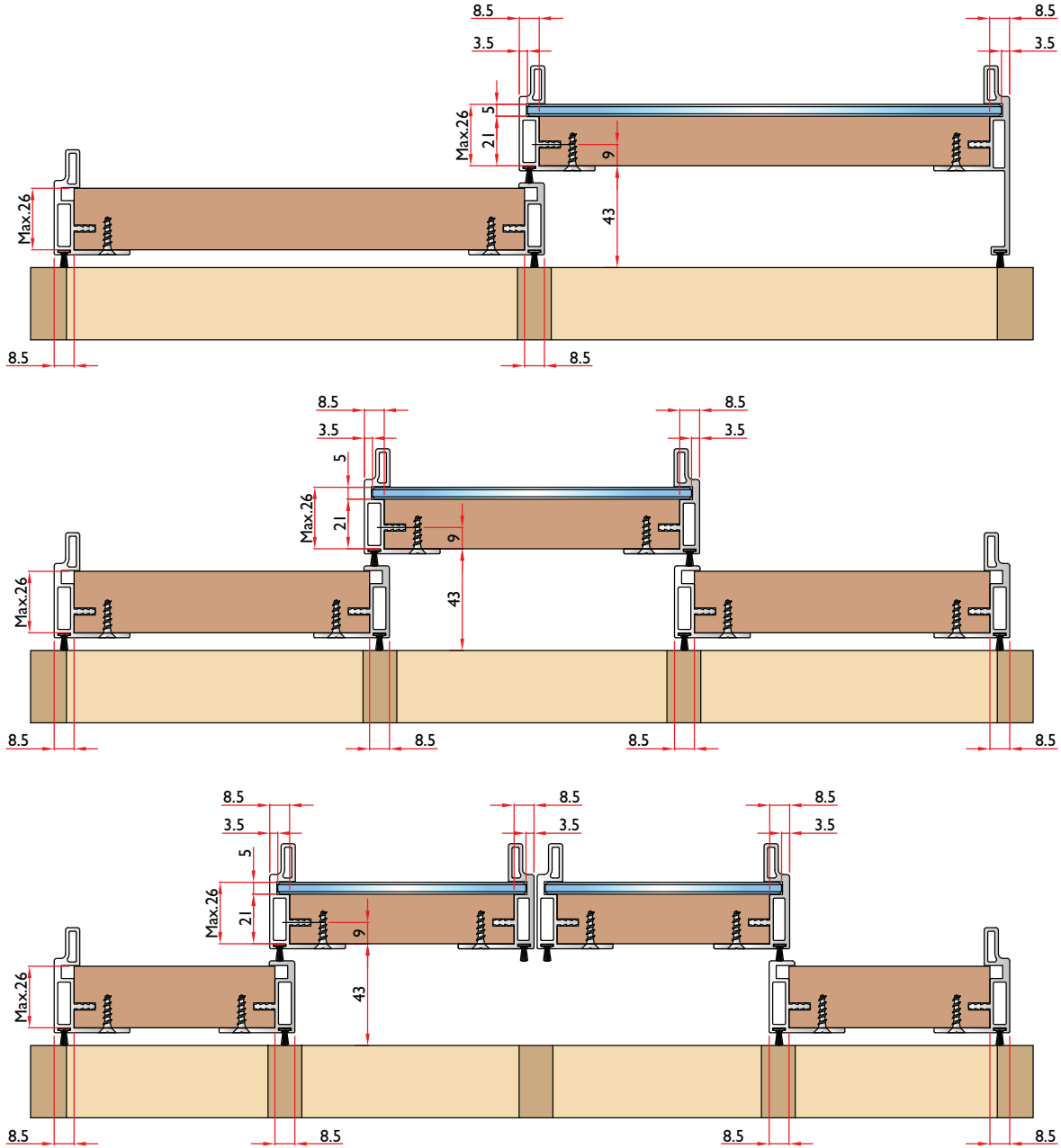

**ART.2220**

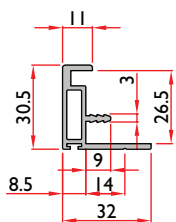

**ART.2222**

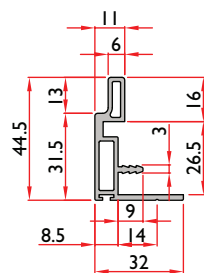

**ART.2224**

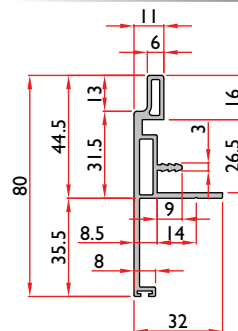

**ART.419**

