

SYSTEMY KRAWĘDZICOWE

edge profiles

anima domus

KATALOG | CATALOGUE

edycja | edition IV/2018

systemy półek szklany
LED slats and profiles

AMS – Alu

elementy do produkcji i oświetlenie LED
elements for the production and LED lighting



profile LED
and profiles

anima domus

*Anima Domus w języku łacińskim oznacza wnętrza z duszą.
Anima Domus – Soul of the Home in latin meaning.*

anima domus

ad

wnętrza z duszą

SPIS TREŚCI | TABLE OF CONTENTS

LISTWY I PROFILE LED LED slats and profiles	str. page ... 4-9
listwy LED LED slats	str. page ... 5-7
oprawy lampshade	str. page ... 7
zaślepki plugs	str. page ... 8
zaczepy fastening	str. page ... 9
RAMKI ALUMINIOWE aluminium frames	str. page ... 10-15
profile ramkowe frame profiles	str. page ... 11-13
akcesoria do montażu ramek frame profiles	str. page ... 14
SYSTEM PRZESUWNY DO RAMEK - miniCabinet sliding system for frames miniCabinet	str. page ... 16-19
wewnętrzne internal system	str. page ... 17
zewewnętrzne external system	str. page ... 18
UCHWYTY handles	str. page ... 20-23
listwy podfrontowe - alternatywa dla uchwytów under furniture facade profiles - alternative solution to handles	str. page ... 21-23
LISTWY KRAWĘDZIOWE edge profiles	str. page ... 24-27
listwy krawędziowe uchwytowe - gotowe odcinki handle edge profiles	str. page ... 25-27
STOPKI MEBLOWE furniture footer construction	str. page ... 28-29
stopki meblowe furniture footer construction	str. page ... 29
AMS – Aluminiowe Moduły Systemowe do budowy regałów AMS shelving aluminium modular system	str. page ... 30-37
elementy systemu system elements	str. page ... 31-37
WALLGLASS - system aluminiowy WALLGLASS - aluminium system	str. page ... 38-39
elementy systemu system elements	str. page ... 39

Listwy i profile LED

LED slats and profiles



innowacyjne i efektywne rozwiązania | innovative and effective solutions

Zobacz, jak w ciekawy sposób możesz wykorzystać nasze rozwiązania www.lagunane.ws.pl
See in what interesting ways can you use our solutions www.lagunane.ws.pl



listwa LED niska
LED slat - low

LL-01

zastosowanie: do montażu podszaflowego
application: mounted under the cupboards

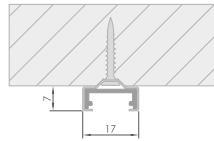

symbol nr	kolor	przekrój	długość		pakowanie
symbol code	color	cross-section	length		packing
51341000	naturalne aluminium natural aluminium	16x6 mm	2 m	3 m	wiązka 40 szt. 40 pcs bundle

listwa LED niska frezowana
inside LED slat - low

LL-02

zastosowanie: do montażu podszaflowego
application: mounted under the cupboards

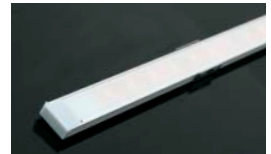
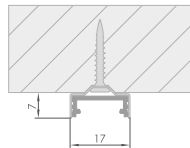

symbol nr	kolor	przekrój	długość		pakowanie
symbol code	color	cross-section	length		packing
51342000	naturalne aluminium natural aluminium	16x6 mm	2 m	3 m	wiązka 40 szt. 40 pcs bundle

listwa LED niska maskująca wpuszczana
inside covering LED slat - low

LL-03

zastosowanie: do montażu podszaflowego
application: mounted under the cupboards

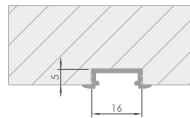

symbol nr	kolor	przekrój	długość		pakowanie
symbol code	color	cross-section	length		packing
51343000	naturalne aluminium natural aluminium	16x6 mm	2 m	3 m	wiązka 40 szt. 40 pcs bundle

listwa LED wysoka frezowana
inside LED slat - high

LL-04

zastosowanie: do montażu podszaflowego
application: mounted under the cupboards

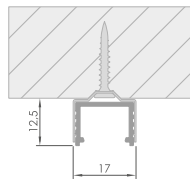
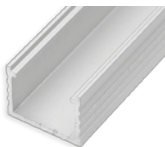

symbol nr	kolor	przekrój	długość		pakowanie
symbol code	color	cross-section	length		packing
51344000	naturalne aluminium natural aluminium	16x12 mm	2 m	3 m	wiązka 40 szt. 40 pcs bundle

listwa LED wysoka maskująca wpuszczana
inside covering LED slat - high

LL-05

zastosowanie: do montażu podszaflowego
application: mounted under the cupboards

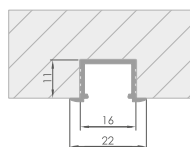
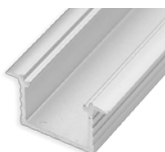

symbol nr	kolor	przekrój	długość		pakowanie
symbol code	color	cross-section	length		packing
5134500 0	naturalne aluminium natural aluminium	16x12 mm	2 m	3 m	wiązka 40 szt. 40 pcs bundle



listwa LED okrągła
round LED slat

LL-06



zastosowanie: do montażu podszafrakowego
application: mounted under the cupboards



symbol nr symbol code	kolor color	przekrój cross-section	dlugość length	pakowanie packing
51346000	naturalne aluminium natural aluminium	16x12 mm - $\varnothing 20$	3 m	wiązka 20 szt. 20 pcs bundle

listwa LED kątowna 90
angle LED slat

LL-07

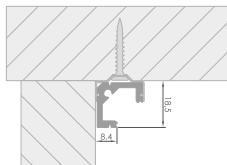
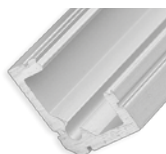

zastosowanie: do montażu podszafrakowego
application: mounted under the cupboards

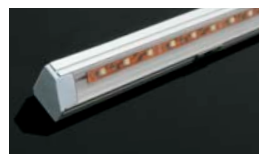

symbol nr symbol code	kolor color	przekrój cross-section	dlugość length	pakowanie packing
51347000	naturalne aluminium natural aluminium	18x18 mm	3 m	wiązka 20 szt. 20 pcs bundle

listwa LED kątowna 90
angle LED slat

LL-07 B

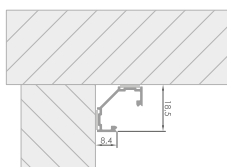
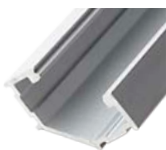

zastosowanie: do montażu podszafrakowego
application: mounted under the cupboards



symbol nr symbol code	kolor color	przekrój cross-section	dlugość length	pakowanie packing	
51333000	naturalne aluminium natural aluminium	18x18 mm	2 m	3 m	wiązka 20 szt. 20 pcs bundle

listwa LED niska
LED slat - low

LL-15

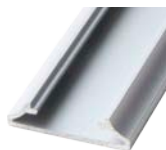

MONTAŻ NA TAŚMĘ!
mounted on double-sided tape

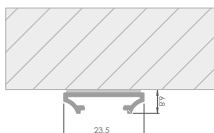

zastosowanie: do montażu podszafrakowego
application: mounted under the cupboards



symbol nr symbol code	kolor color	przekrój cross-section	dlugość length	pakowanie packing	
51334000	naturalne aluminium natural aluminium	16x6 mm	2 m	3 m	wiązka 40 szt. 40 pcs bundle

profil do półek z płyty
profile for board shelves

LL-08

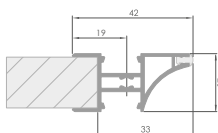
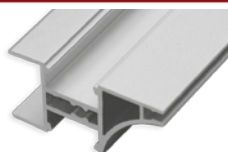

zastosowanie: do montażu wieńcowego
application: mounting coronary



symbol nr symbol code	kolor color	przekrój cross-section	dlugość length	pakowanie packing
51330000	naturalne aluminium natural aluminium	41x20 mm	3 m	wiązka 20 szt. 20 pcs bundle



profil do półek z płyty z miejscem na zasilacz
profile for board shelves with space for power feeder

LL-09

zastosowanie: do montażu wieńcowego
application: mounting coronary

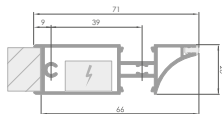
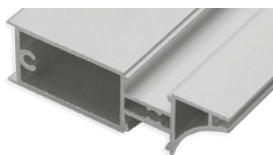

symbol nr	kolor	przekrój	długość	pakowanie
symbol code	color	cross-section	length	packing
51331000	naturalne aluminium natural aluminium	68x20 mm	3 m	wiązka 20 szt. 20 pcs bundle

profil LED
LED profile

LL-16

profil LED
LED profile

LL-17

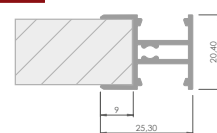
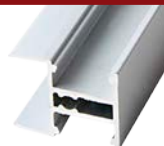
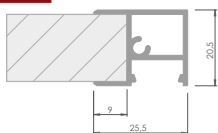

symbol nr	kolor	przekrój	długość	pakowanie
symbol code	color	cross-section	length	packing
51335000	naturalne aluminium natural aluminium	16x6 mm	3 m	wiązka 40 szt. 40 pcs bundle
51336000				

profil LED
LED profile

LL-19

zastosowanie: do montażu wieńcowego w pionie i poziomo
application: vertical and horizontal mounting in the rim profile

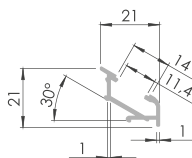

symbol nr	kolor	przekrój	długość	pakowanie
symbol code	color	cross-section	length	packing
51338000	naturalne aluminium natural aluminium	21x21 mm	3 m	wiązka 30 szt. 30 pcs bundle

dyfuzory bezbarwne
transparent lampshade

OLL-02
OLL-08



OLL-04



OLL-06
OLL-10

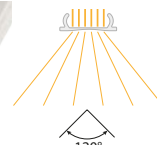

symbol nr	przekrój	materiał	długość
symbol code	cross-section	material	length
51348100	~14x4 mm	PC	2 m 3 m
51348130		PVC	3 m

symbol nr	przekrój	materiał	długość
symbol code	cross-section	material	length
51348110	~14x8 mm	PC	3 m

symbol nr	przekrój	materiał	długość
symbol code	cross-section	material	length
51348120	~14x4 mm	PC	3 m
51348140		PVC	

dyfuzory mleczne
frosted lampshade

OLL-01
OLL-07



OLL-03



OLL-05
OLL-09

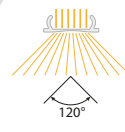

symbol nr	przekrój	materiał	długość
symbol code	cross-section	material	length
51348000	~14x4 mm	PC	2 m 3 m
51348030		PVC	3 m

symbol nr	przekrój	materiał	długość
symbol code	cross-section	material	length
51348010	~14x8 mm	PC	3 m

symbol nr	przekrój	materiał	długość
symbol code	cross-section	material	length
51348020	~14x4 mm	PC	3 m
51348040		PVC	



zaślepka do LL-01 i LL-02
plug for LL-01 and LL-02

ZLL-01 ZLL-02

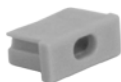

symbol nr	kolor	symbol nr
symbol code	color	symbol code
51348200	naturalny natural	51348300

zaślepka do LL-03
plug for LL-03

ZLL-03 ZLL-04

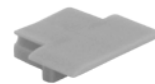

symbol nr	kolor	symbol nr
symbol code	color	symbol code
51348400	naturalny natural	51348500

zaślepka do LL-04
plug for LL-04

ZLL-05 ZLL-06



symbol nr	kolor	symbol nr
symbol code	color	symbol code
51348600	naturalny natural	51348700

zaślepka do LL-05
plug for LL-05

ZLL-07 ZLL-08

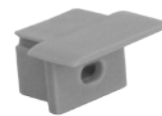
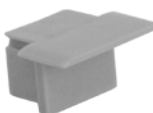

symbol nr	kolor	symbol nr
symbol code	color	symbol code
51348800	naturalny natural	51348900

zaślepka do LL-06
plug for LL-06

ZLL-09 ZLL-10



symbol nr	kolor	symbol nr
symbol code	color	symbol code
51349000	naturalny natural	51349100

zaślepka do LL-07 i LL-07 B
plug for LL-07 and LL-07 B

ZLL-11 ZLL-12



symbol nr	kolor	symbol nr
symbol code	color	symbol code
51349200	naturalny natural	51349300

zaślepka do LL-19
plug for LL-06

ZLL-15



lewa



prawa

symbol nr	kolor	symbol nr
symbol code	color	symbol code
51349600	naturalny natural	51349700

zaślepka do LL-19
plug for LL-19

ZLL-16



lewa



prawa

symbol nr	kolor	symbol nr
symbol code	color	symbol code
51349800	naturalny natural	51349900

zaślepka do LL-15
plug for LL-15

ZLL-13 ZLL-14



symbol nr	symbol nr	kolor
symbol code	symbol code	color
51349400	51349500	naturalny natural

komplet montażowy do LL-08 i LL-09
assembly set for LL-08 and LL-09

KLL-01 KLL-02

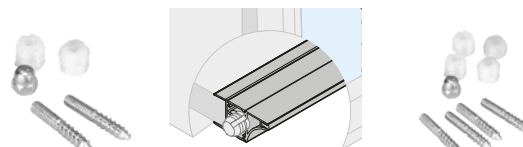

symbol nr	symbol nr
symbol code	symbol code
51330100	51331100



zaczep z metalu do LL-01
metal fastening for LL-01

MLL-01

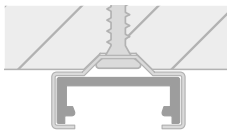

symbol nr	kolor
symbol code	color
51340100	naturalny natural

zaczep z metalu do LL-02 i LL-03
metal fastening for LL-02 and LL-03

MLL-02

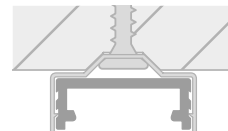
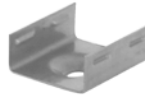

symbol nr	kolor
symbol code	color
51340200	naturalny natural

zaczep z metalu do LL-04 i LL-05
metal fastening for LL-04 and LL-05

MLL-03

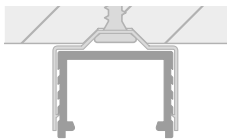
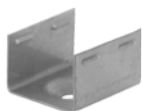

symbol nr	kolor
symbol code	color
51340400	naturalny natural

zaczep z metalu do LL-06
metal fastening for LL-06

MLL-04

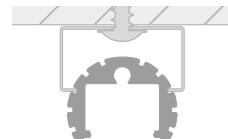

symbol nr	kolor
symbol code	color
51340600	naturalny natural

zaczep z metalu do LL-07
metal fastening for LL-07

MLL-05

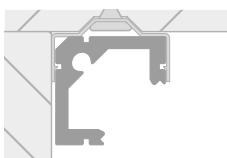
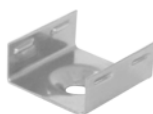

symbol nr	kolor
symbol code	color
51340700	naturalny natural

zaczep z tworzywa do LL-01 i LL-02
plastic fastening for LL-01 and LL-02

MLL-06 PC

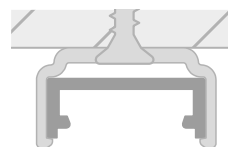

symbol nr	kolor
symbol code	color
51340300	naturalny natural

zaczep z tworzywa do LL-03, LL-04, LL-05
plastic fastening for LL-03, LL-04, LL-05

MLL-07 PC

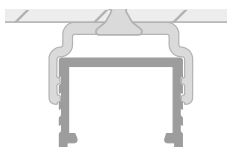

symbol nr	kolor
symbol code	color
51340500	naturalny natural

zaczep z tworzywa do LL-07B, LL-19
plastic fastening for LL-03, LL-04, LL-05

MLL-09 PC

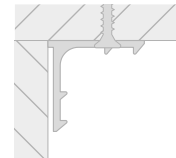
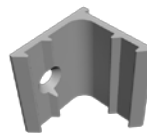

symbol nr	kolor
symbol code	color
51340500	naturalny natural

uszczelka do LL-08 i LL-09
seal to LL-08 and LL-09

ULL-01

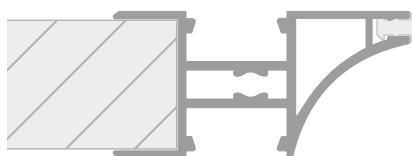

symbol nr	kolor
symbol code	color
51340000	naturalny natural

RAMKI ALUMINIOWE

aluminium frames



subtelne połączenie profili aluminiowych | subtle connection of aluminium profile and glass



profil ramkowy
frame profile

A1

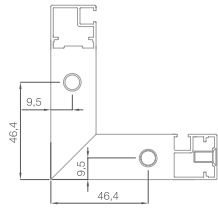
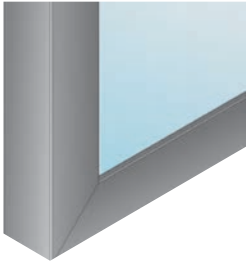

kątownik N2
N2 angle

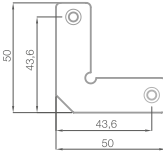

zamiennie można
użyć kątownika N1
we also can use angle N1

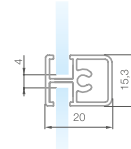
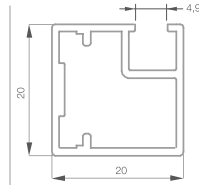

opcja zastosowania
profilu łączącego P1
P1 connection profile option
nr 51600000

symbol	nr	kolor	przekrój	długość	jedn. waga	wypełnienie	gr. wypełnienia	pakowanie	waga wiązki
symbol	code	color	cross-section	length	weight	filling	thickness	packing	bundle
A1	51601000	naturalne aluminium natural aluminium	20 x 20 mm	5,5 m	0,29 kg/m	szkło glass	4 mm	wiązka 16 szt. 16 pcs bundle	26 kg
	51601090	inox inox							

profil ramkowy
frame profile

A4

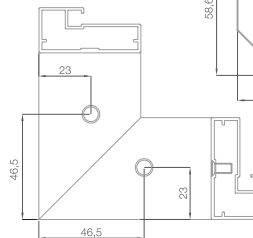
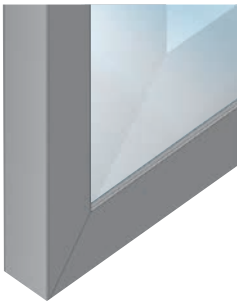

kątownik N3
N3 angle

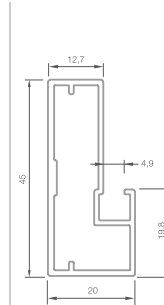
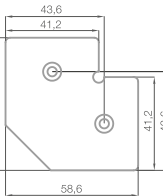

symbol	nr	kolor	przekrój	długość	jedn. waga	wypełnienie	gr. wypełnienia	pakowanie	waga wiązki
symbol	code	color	cross-section	length	weight	filling	thickness	packing	bundle
A4	51604000	naturalne aluminium natural aluminium	20 x 45 mm	5,5 m	0,59 kg/m	szkło glass	4 mm	wiązka 8 szt. 8 pcs bundle	26 kg
	51604090	inox inox							

profil ramkowy
frame profile

A5

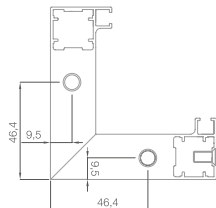

kątownik N2
N2 angle

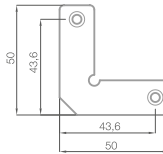

zamiennie można
użyć kątownika N1
we also can use angle N1

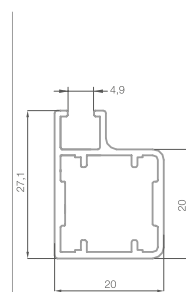

symbol	nr	kolor	przekrój	długość	jedn. waga	wypełnienie	gr. wypełnienia	pakowanie	waga wiązki
symbol	code	color	cross-section	length	weight	filling	thickness	packing	bundle
A5	51605000	naturalne aluminium natural aluminium	20 x 27,1 mm	5,5 m	0,34 kg/m	szkło glass	4 mm	wiązka 16 szt. 16 pcs bundle	30 kg



profil ramkowy
frame profile

A8



kątownik N2
N2 angle

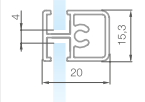
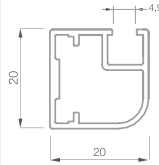
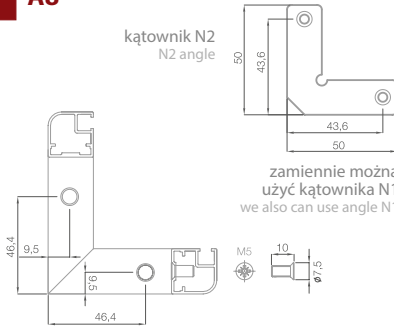

opcja zastosowania
profilu łączącego P1
P1 connection profile option
nr 160000

symbol	nr	kolor	przekrój	długość	jedn. waga	wypełnienie	gr. wypełnienia	pakowanie	waga wiązki
symbol	code	color	cross-section	length	weight	filling	thickness	packing	bundle
A8	160800	naturalne aluminium natural aluminium	20 x 20 mm	5,5 m	0,28 kg/m	szkło glass	4 mm	wiązka 16 szt. 16 pcs bundle	25 kg

profil ramkowy
frame profile

A9



kątownik N3
N3 angle

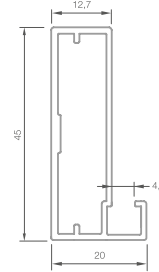
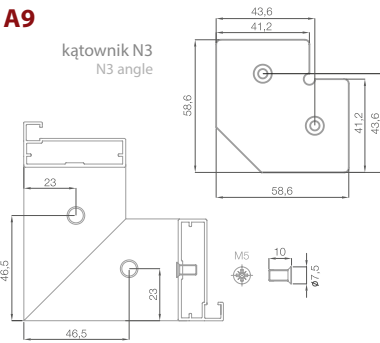

symbol	nr	kolor	przekrój	długość	jedn. waga	wypełnienie	gr. wypełnienia	pakowanie	waga wiązki
symbol	code	color	cross-section	length	weight	filling	thickness	packing	bundle
A9	160900	naturalne aluminium natural aluminium	20x45x12,7 mm	5,5 m	0,41 kg/m	szkło glass	4 mm	wiązka 10 szt. 10 pcs bundle	23 kg
	160909	inox inox							

profil ramkowy
frame profile

A10



kątownik N2
N2 angle

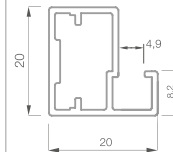
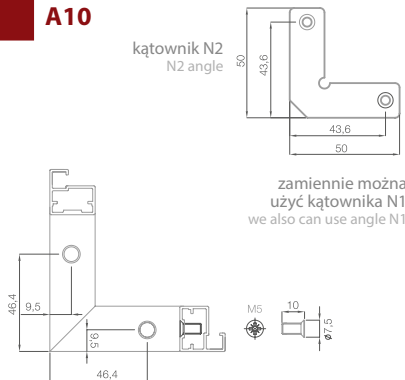

symbol	nr	kolor	przekrój	długość	jedn. waga	wypełnienie	gr. wypełnienia	pakowanie	waga wiązki
symbol	code	color	cross-section	length	weight	filling	thickness	packing	bundle
A10	161000	naturalne aluminium natural aluminium	20 x 20 mm	5,5 m	0,27 kg/m	szkło glass	4 mm	wiązka 16 szt. 16 pcs bundle	24 kg



kątowniki montażowe
assembling angles

N1 | N2 | N3

wkręt M5
screw M5

nr 51699050

pomniejszony łeb
flatten screw head

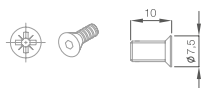

kątownik N1
angle N1

nr 51699010

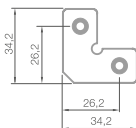

kątownik N2
angle N2

nr 51699020

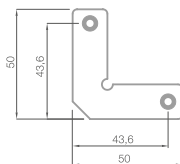

kątownik N3
angle N3

nr 51699030

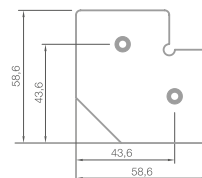

jedn. waga	pakowanie
weight	packing
0,01 kg	500 szt.

jedn. waga	pakowanie
weight	packing
0,02 kg	500 szt.

jedn. waga	pakowanie
weight	packing
0,03 kg	400 szt.

jedn. waga	pakowanie
weight	packing
0,06 kg	300 szt.

uszczelka do montażu szkła
seal for glass

Z4

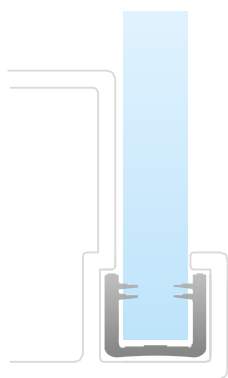

Do wszystkich profili pasuje ta sama uszczelka płaska do szkła. Zapewniamy specjalne wkręty M5 z pomniejszonym łebem, co umożliwi bardziej estetyczne wykonanie ramek.

To all profiles fit the same seal for the glass. We provide special screws M5 with smaller head, thanks to those screws ready frames are more aesthetic.

symbol	nr	rolka	waga
symbol	code	roll	weight
Z4	51699040	100 m	4 kg



SYSTEM PRZESUWNY DO RAMEK - miniCabinet sliding system for frames - miniCabinet



lekkie przesuwanie, więcej możliwości | smooth sliding, more possibilities



mini cabinet | system przesuwny do ramy | wewnętrzny

mini cabinet | sliding system for frames | internat system

animadomus
ad
wnętrza z duszą

mini cabinet wewnętrzny mini cabinet internal system

15 kg na 1 skrzydło
on 1 door leaf



opcje torów na powierzchni płyty
rails on board surface

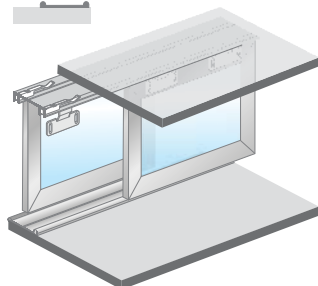

widok elementów jezdnych
wewnątrz mebla
view of sliding elements inside the furniture

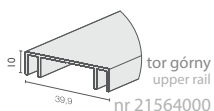
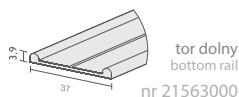
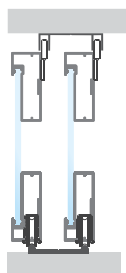

symbol	nr	kolor*	długość*	jedn. waga	pakowanie	waga wiązki	* informacje dodatkowe
symbol	code	color*	length*	weight	packing	bundle	* additional informations
Tor górny MiniCabinet upper rail MiniCabinet	21564000	naturalne aluminium natural aluminium	5,5 m	0,24 kg/m	20 szt./pcs wiązka board	26 kg	* dostępne także inne kolory oraz wykończenia powierzchni other colours and surface types available * listwy dostępne w innych odciinkach (podział 5,5 m) profiles individually available in other length (divided 5,5 m) * opcjonalnie płyta meblowa optional furniture board
Tor dolny MiniCabinet lower rail MiniCabinet	21563000			0,18 kg/m		20 kg	



opcje torów wpuszczanych we frez
rails to slothing cutter option

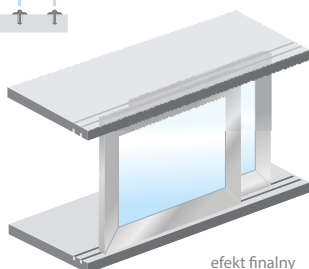

efekt finalny
widoczna strona mebla
final effect of visible side of furniture



symbol	nr	kolor*	długość*	jedn. waga	pakowanie	waga wiązki	* informacje dodatkowe
symbol	code	color*	length*	weight	packing	bundle	* additional informations
Tor górny MiniCabinet upper rail MiniCabinet	21568000	naturalne aluminium natural aluminium	5,5 m	0,07 kg/m	20 szt./pcs wiązka board	8 kg	* dostępne także inne kolory oraz wykończenia powierzchni other colours and surface types available * listwy dostępne w innych odciinkach (podział 5,5 m) profiles individually available in other length (divided 5,5 m) * opcjonalnie płyta meblowa optional furniture board
Tor dolny MiniCabinet lower rail MiniCabinet	21567000			0,22 kg/m		24 kg	

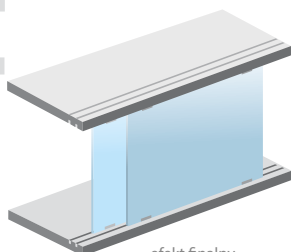

efekt finalny
widoczna strona mebla
final effect of visible side of furniture

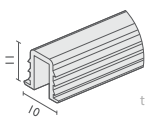
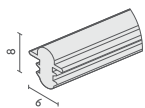
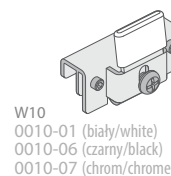
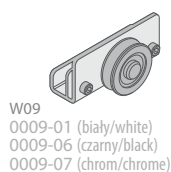
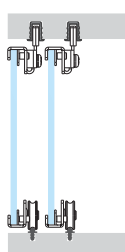

symbol	nr	kolor*	długość*	jedn. waga	pakowanie	waga wiązki	* informacje dodatkowe
symbol	code	color*	length*	weight	packing	bundle	* additional informations
Tor górny MiniCabinet upper rail MiniCabinet	21568000	naturalne aluminium natural aluminium	5,5 m	0,07 kg/m	20 szt./pcs wiązka board	8 kg	* dostępne także inne kolory oraz wykończenia powierzchni other colours and surface types available * listwy dostępne w innych odciinkach (podział 5,5 m) profiles individually available in other length (divided 5,5 m)
Tor dolny MiniCabinet lower rail MiniCabinet	21567000			0,22 kg/m		24 kg	



mini cabinet zewnętrzny
mini cabinet external system

15 kg na 1 skrzydło
on 1 door leaf

opcja | skrzydło na zewnątrz
tory na zewnątrz
door leaf and rails
fully outside of the furniture corps

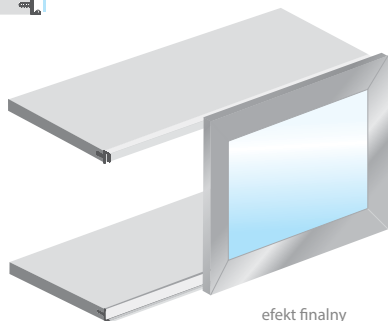

efekt finalny
widoczna strona mebla
final effect of visible side of furniture

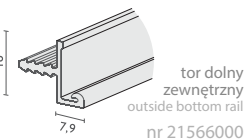
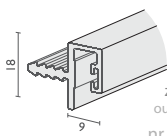
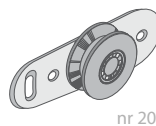
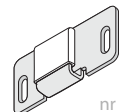
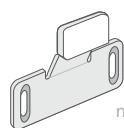
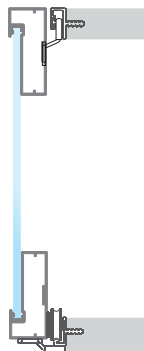

symbol	nr	kolor*	długość*	jedn. waga	pakowanie	waga wiązki	* informacje dodatkowe
symbol	code	color*	length*	weight	packing	bundle	* additional informations
Tor górny MiniCabinet upper rail MiniCabinet	21565000	naturalne aluminium natural aluminium	5,5 m	0,23 kg/m	20 szt./pcs wiązka board	25 kg	* dostępne także inne kolory oraz wykończenia powierzchni other colours and surface types available * listwy dostępne w innych odcinkach (podział 5,5 m) profiles individually available in other length (divided 5,5 m)
Tor dolny MiniCabinet lower rail MiniCabinet	21566000	naturalne aluminium natural aluminium	5,5 m	0,19 kg/m	20 szt./pcs wiązka board	21 kg	* opcjonalnie płyta meblowa optional furniture board

opcja | skrzydło na zewnątrz
tory wewnątrz
door leaf outside
with rails inside the furniture corps

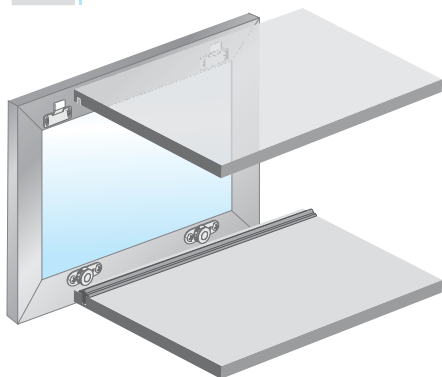

widok elementów jezdnych
wewnątrz mebla
view of sliding elements inside the furniture

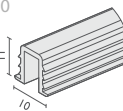
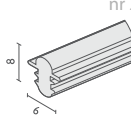
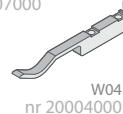
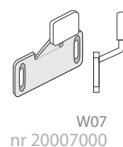
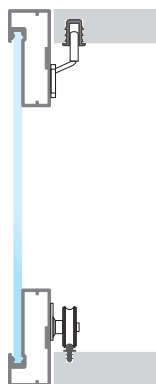

symbol	nr	kolor*	długość*	jedn. waga	pakowanie	waga wiązki	* informacje dodatkowe
symbol	code	color*	length*	weight	packing	bundle	* additional informations
Tor górny MiniCabinet upper rail MiniCabinet	21568000	naturalne aluminium natural aluminium	5,5 m	0,07 kg/m	20 szt./pcs wiązka board	8 kg	* dostępne także inne kolory oraz wykończenia powierzchni other colours and surface types available * listwy dostępne w innych odcinkach (podział 5,5 m) profiles individually available in other length (divided 5,5 m)
Tor dolny MiniCabinet lower rail MiniCabinet	21567000	naturalne aluminium natural aluminium	5,5 m	0,22 kg/m	20 szt./pcs wiązka board	24 kg	* opcjonalnie płyta meblowa optional furniture board



UCHWYTY

handles



ergonomiczne rozwiązania do wykończenia mebli | ergonomic solution for furniture



uchwyt U
handle U

U

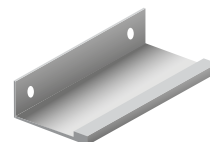
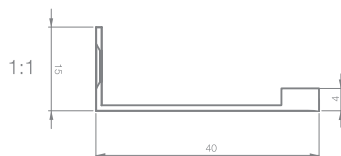
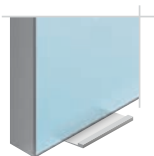

symbol	nr	kolor*	przekrój	długość*	jedn. waga	rozstaw otworów	* informacje dodatkowe
symbol	code	color*	cross-section	length*	weight	bundle	* additional informations
U-50	51709000	naturalne aluminium natural aluminium	15 x 40 mm	50 mm	0,09 kg	32 mm	* dostępne także inne kolory oraz wykończenia powierzchni other colours and surface types available * listwy dostępne w długościach do 2,7 m na zamówienie handles individually available in 2,7 m length
U-100	51710000			100 mm	0,17 kg	64 mm	
U	51711000			5,5 m	1,00 kg	–	

listwa podfrontowa końcowa
under front ending profile

LB 51425000

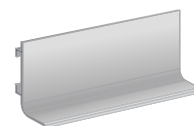
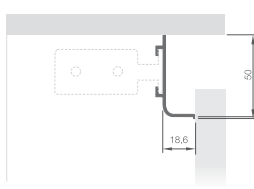

symbol	nr	kolor*	długość*	jedn. waga	pakowanie	waga wiązki	* informacje dodatkowe
symbol	code	color*	length*	weight	packing	bundle	* additional informations
LB	51425000	naturalne aluminium natural aluminium	5,5 m	0,31 kg/m	10 szt./pcs wiązka bundle	17 kg	* dostępne także inne kolory oraz wykończenia powierzchni other colours and surface types available * listwy dostępne w innych odcinkach (podział 5,5 m) profiles individually available in other length (divided 5,5 m)

listwa podfrontowa pełna
under front full profilet

LB 51426000

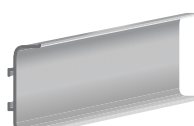
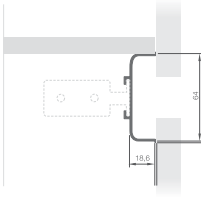

symbol	nr	kolor*	długość*	jedn. waga	pakowanie	waga wiązki	* informacje dodatkowe
symbol	code	color*	length*	weight	packing	bundle	* additional informations
LB	51426000	naturalne aluminium natural aluminium	5,5 m	0,43 kg/m	10 szt./pcs wiązka bundle	24 kg	* dostępne także inne kolory oraz wykończenia powierzchni other colours and surface types available * listwy dostępne w innych odcinkach (podział 5,5 m) profiles individually available in other length (divided 5,5 m)

kątownik montażowy
mounting corner

ZK 51427000

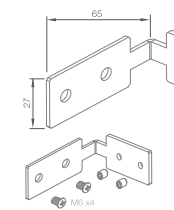

symbol	nr	kolor*	długość*	jedn. waga	pakowanie	waga wiązki	* informacje dodatkowe
symbol	code	color*	length*	weight	packing	bundle	* additional informations
ZK	51427000	naturalne aluminium natural aluminium	–	0,06 kg/szt	1 szt. 1 pcs	0,24 kg	–



profil podfrontowy C-L
under front ending profile C-L

PP C-L

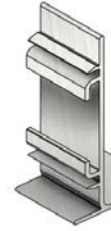
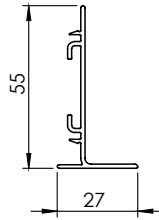
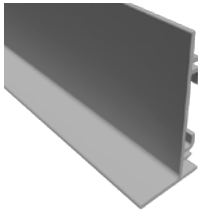

symbol	nr	kolor*	długość*	jedn. waga	pakowanie
symbol	code	color*	length*	weight	packing
PP C-L	51425100	naturalne aluminium natural aluminium	5,5 m	2,10 kg	20 szt./pcs wiązka bundle.

zaślepka do LB C-L
plug for LB C-L

LB C-L

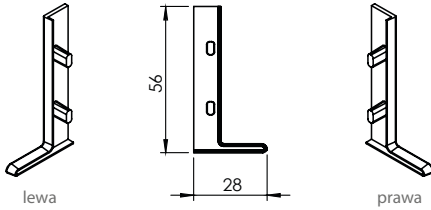

lewa

prawa

symbol nr	kolor	symbol nr
symbol code	color	symbol code
51425300	naturalny natural	51425200

zaślepka do PP C-L
plug for PP C-L

LB C-L pełna

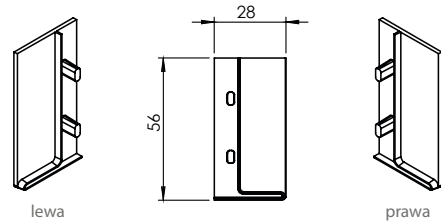

lewa

prawa

symbol nr	kolor	symbol nr
symbol code	color	symbol code
51425700	naturalny natural	51425600

łącznik kątowy LB C-L wewnętrzny
angle connector for LB C-L inside

LB C-L wew.



symbol nr	kolor
symbol code	color
51425400	naturalny natural

łącznik kątowy LB C-L zewnętrzny
angle connector for LB C-L outside

LB C-L zew.

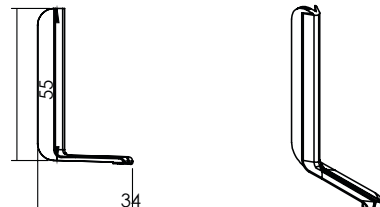

symbol nr	kolor
symbol code	color
51425500	naturalny natural

kątownik montażowy ZK
mounting corner ZK

ZK

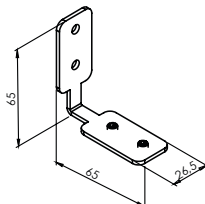

symbol nr	kolor
symbol code	color
51427000	naturalny natural

klips montażowy C
mounting clip C

C

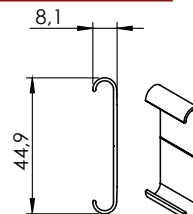

symbol nr	kolor
symbol code	color
51427100	naturalny natural



profil podfrontowy C-C
under front ending profile C-C

PP C-C

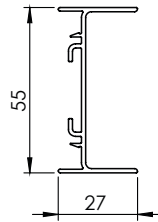
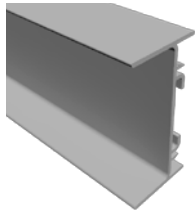

symbol	nr	kolor*	długość*	jedn. waga	pakowanie
symbol	code	color*	length*	weight	packing
PP C-C	51426100	naturalne aluminium natural aluminium	5,5 m	2,65 kg	10 szt./pcs wiązka bundle.

zaślepka do LB C-C
plug for LB C-C

LB C-C

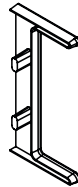
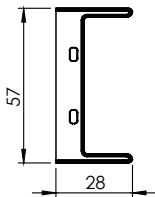

symbol nr	kolor
symbol code	color
51426200	naturalny natural

zaślepka do LB C-L
plug for LB C-C filled

LB C-C pełna

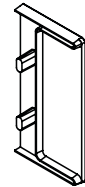
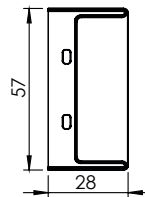

symbol nr	kolor
symbol code	color
51426300	naturalny natural

łącznik kątowy LB C-C wewnętrzny
angle connector for LB C-C inside

LB C-C wew.

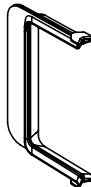
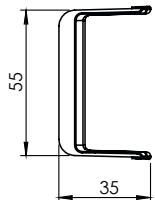

symbol nr	kolor
symbol code	color
51426400	naturalny natural

łącznik kątowy LB C-C zewnętrzny
angle connector for LB C-C outside

LB C-Czew.

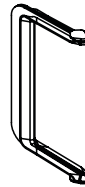
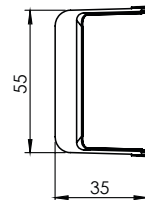

symbol nr	kolor
symbol code	color
51426500	naturalny natural

kątownik montażowy ZK
mounting corner ZK

ZK

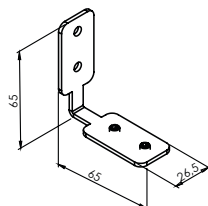

symbol nr	kolor
symbol code	color
51427000	naturalny natural

klips montażowy C
mounting clip C

C

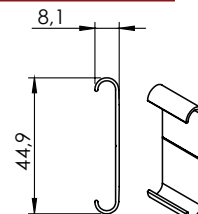

symbol nr	kolor
symbol code	color
51427100	naturalny natural

LISTWY KRAWĘDZIOWE

edge profiles



ekskluzywna linia w nowoczesnych meblach | exclusive line in modern furniture

LKW 4 - 40 w gotowych odcinkach przygotowanych do montażu

LKW 4 - 40 edge profiles in ready to use length with bevelled edges

symbol	nr	długość	jednostka	kolor*
symbol	code	length	sale unit	color*
LKW 4	51141000.40	40 cm	szt. / pcs	naturalne aluminium
LKW 4	51141000.45	45 cm	szt. / pcs	
LKW 4	51141000.50	50 cm	szt. / pcs	
LKW 4	51141000.60	60 cm	szt. / pcs	
LKW 5	51136000.40	40 cm	szt. / pcs	
LKW 5	51136000.45	45 cm	szt. / pcs	
LKW 5	51136000.50	50 cm	szt. / pcs	
LKW 5	51136000.60	60 cm	szt. / pcs	
LKW 7	51142000.40	40 cm	szt. / pcs	
LKW 7	51142000.45	45 cm	szt. / pcs	
LKW 7	51142000.50	50 cm	szt. / pcs	
LKW 7	51142000.60	60 cm	szt. / pcs	
LKW 8	51144000.40	40 cm	szt. / pcs	
LKW 8	51144000.45	45 cm	szt. / pcs	
LKW 8	51144000.50	50 cm	szt. / pcs	
LKW 8	51144000.60	60 cm	szt. / pcs	

symbol	nr	długość	jednostka	kolor*
symbol	code	length	sale unit	color*
KLW 10	51143000.40	40 cm	szt. / pcs	naturalne aluminium
LKW 10	51143000.45	45 cm	szt. / pcs	
LKW 10	51143000.50	50 cm	szt. / pcs	
LKW 10	51143000.60	60 cm	szt. / pcs	
LKW 18	51135000.40	40 cm	szt. / pcs	
LKW 18	51135000.45	45 cm	szt. / pcs	
LKW 18	51135000.50	50 cm	szt. / pcs	
LKW 18	51135000.60	60 cm	szt. / pcs	
LKW 29	51133000.40	40 cm	szt. / pcs	
LKW 29	51133000.45	45 cm	szt. / pcs	
LKW 29	51133000.50	50 cm	szt. / pcs	
LKW 29	51133000.60	60 cm	szt. / pcs	
LKW 40	51134000.40	40 cm	szt. / pcs	
LKW 40	51134000.45	45 cm	szt. / pcs	
LKW 40	51134000.50	50 cm	szt. / pcs	
LKW 40	51134000.60	60 cm	szt. / pcs	

*inne długości dostępne na indywidualne zamówienie | individually other lengths available

fazowane końcówki pióra bevelled edges

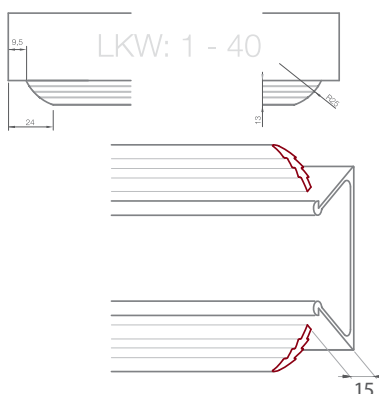
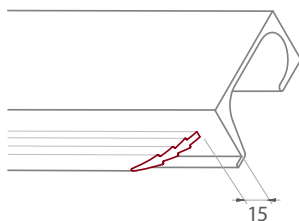
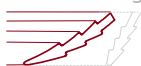

wykończone powierzchnie boczne
prepared side surfaces

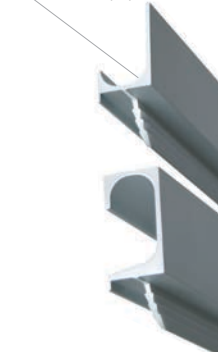

listwa krawędziowa uchwytna edge handle profile

LKW1
LKW2

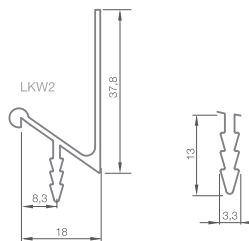
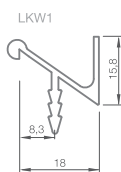

symbol	nr	kolor*	gr. płyty*	długość*	jedn. waga	pakowanie	waga wiązki	* informacje dodatkowe
symbol	code	color*	board thick.	length*	weight	packing	bundle	* additional informations
LKW 1	51138000	naturalne aluminium natural aluminium	18 mm	5,5 mm	0,25 kg/m	12 szt./pcs wiązka board	16,5 kg	* dostępne także inne kolory oraz wykończenia powierzchni other colours and surface types available * listwy dostępne w innych odcinkach (podział 5,5 m) profiles individually available in other length (divided 5,5 mm)
LKW 2	51139000				0,33 kg/m		21,78 kg	

listwa krawędziowa uchwytywowa
edge handle profile

LKW4

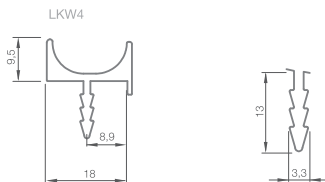

symbol	nr	kolor*	gr. płyty*	długość*	jedn. waga	pakowanie	waga wiązki	* informacje dodatkowe
symbol	code	color*	board thick.	length*	weight	packing	bundle	* additional informations
LKW 4	51141000	naturalne aluminium natural aluminium	18 mm	5,5 m	0,28 kg/m	15 szt./pcs	23 kg	* dostępne także inne kolory oraz wykończenia powierzchni other colours and surface types available * listwy dostępne w innych odcinkach (podział 5,5m) profiles individually available in other length (divided 5,5m)

listwa krawędziowa uchwytywowa
edge handle profile

LKW5

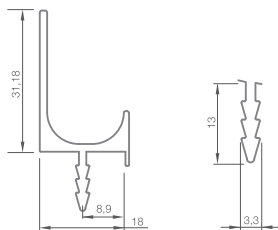

symbol	nr	kolor*	gr. płyty*	długość*	jedn. waga	pakowanie	waga wiązki	* informacje dodatkowe
symbol	code	color*	board thick.	length*	weight	packing	bundle	* additional informations
LKW 5	51136000	naturalne aluminium natural aluminium	18 mm	5,5 m	0,38 kg/m	8 szt./pcs wiązka board	17 kg	* dostępne także inne kolory oraz wykończenia powierzchni other colours and surface types available * listwy dostępne w innych odcinkach (podział 5,5 m) profiles individually available in other length (divided 5,5 m)

listwa krawędziowa uchwytywowa
edge handle profile

**LKW7
LKW8**

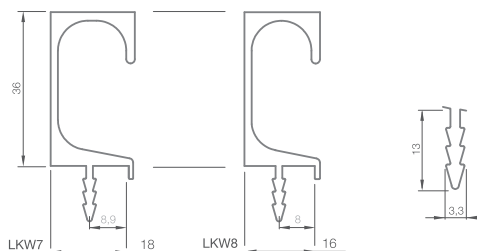

symbol	nr	kolor*	gr. płyty*	długość*	jedn. waga	pakowanie	waga wiązki	* informacje dodatkowe
symbol	code	color*	board thick.	length*	weight	packing	bundle	* additional informations
LKW 7	51142000	naturalne aluminium natural aluminium	18 mm	5,5 m	0,65 kg/m	8 szt./pcs wiązka board	29 kg	* dostępne także inne kolory oraz wykończenia powierzchni other colours and surface types available * listwy dostępne w innych odcinkach (podział 5,5 m) profiles individually available in other length (divided 5,5 m)
LKW 8	51144000		16 mm		0,60 kg/m		29 kg	

listwa krawędziowa uchwykowa edge handle profile

LKW10

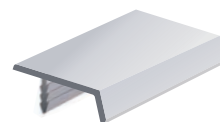
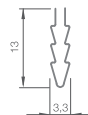
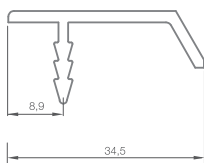
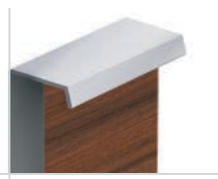

symbol	nr	kolor*	gr. płyty*	długość*	jedn. waga	pakowanie	waga wiązki	* informacje dodatkowe
symbol	code	color*	board thick.	length*	weight	packing	bundle	* additional informations
LKW 10	51143000	naturalne aluminium natural aluminium	18 mm	5,5 m	0,28 kg/m	12 szt./pcs wiązka board	19 kg	* dostępne także inne kolory oraz wykończenia powierzchni other colours and surface types available * listwy dostępne w innych odcinkach (podział 5,5 m) profiles individually available in other length (divided 5,5 m)

listwa krawędziowa wykończeniowa edge finishing profile

LKW29 LKW40

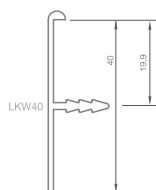
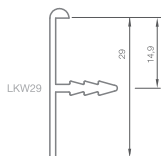

symbol	nr	kolor*	gr. płyty*	długość*	jedn. waga	pakowanie	waga wiązki	* informacje dodatkowe
symbol	code	color*	board thick.	length*	weight	packing	bundle	* additional informations
LKW 29	51133000	naturalne aluminium natural aluminium	29 mm	5,5 m	0,18 kg/m	20 szt./pcs	20 kg	* dostępne także inne kolory oraz wykończenia powierzchni other colours and surface types available * listwy dostępne w innych odcinkach (podział 5,5 m) profiles individually available in other length (divided 5,5 m)
LKW 40	51134000	naturalne aluminium natural aluminium	40 mm		0,22 kg/m	16 szt./pcs	19 kg	

listwa krawędziowa wykończeniowa edge finishing profile

LKW18

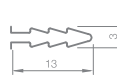
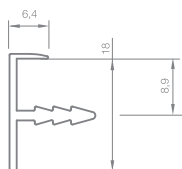

symbol	nr	kolor*	gr. płyty*	długość*	jedn. waga	pakowanie	waga wiązki	* informacje dodatkowe
symbol	code	color*	board thick.	length*	weight	packing	bundle	* additional informations
LKW 18	51135000	naturalne aluminium natural aluminium	18 mm	5,5 m	0,14 kg/m	21 szt./pcs wiązka board	20 kg	* dostępne także inne kolory oraz wykończenia powierzchni other colours and surface types available * listwy dostępne w innych odcinkach (podział 5,5 m) profiles individually available in other length (divided 5,5 m)

STOPKI MEBLOWE

furniture aluminium footing



solidny fundament nowoczesnych mebli | solid base for modern furniture



zastosowanie
purpose

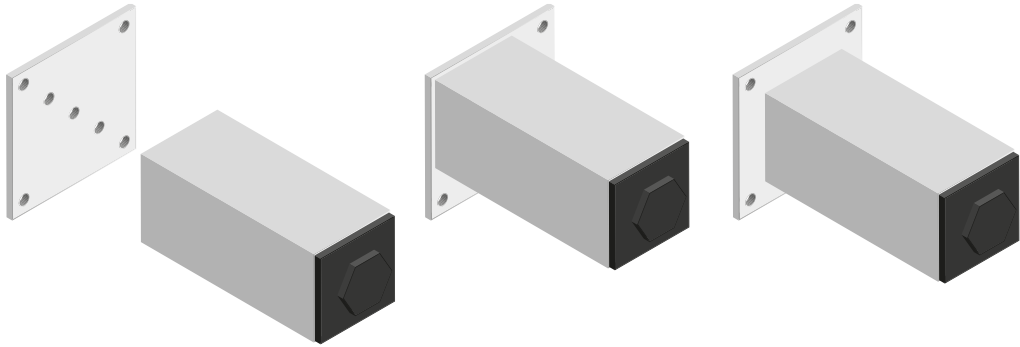

stopka meblowa stała
footer without height adjustment

SM-S

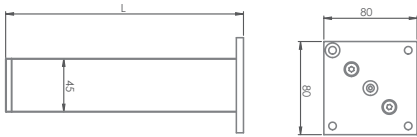

symbol	nr	kolor	wysokość L [mm]	pakowanie	jedn. waga
symbol	code	color	height L [mm]	packing	weight
SM-S	51211000	naturalne aluminium natural aluminium	100	1 szt./pcs	0,16 kg
SM-S	51211500	naturalne aluminium natural aluminium	150	1 szt./pcs	0,18 kg
SM-S	51212000	naturalne aluminium natural aluminium	200	1 szt./pcs	0,20 kg

stopka meblowa regulowana
footer with height adjustment

SM-R

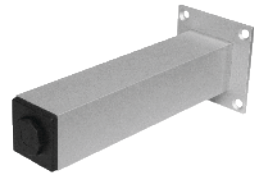
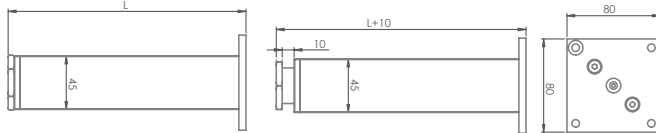

symbol	nr	kolor	wysokość L [mm]	pakowanie	jedn. waga
symbol	code	color	height L [mm]	packing	weight
SM-R	51221000	naturalne aluminium natural aluminium	100	1 szt./pcs	0,22 kg
SM-R	51221500	naturalne aluminium natural aluminium	150	1 szt./pcs	0,24 kg
SM-R	51222000	naturalne aluminium natural aluminium	200	1 szt./pcs	0,26 kg

stopka cokołowa
assembly set

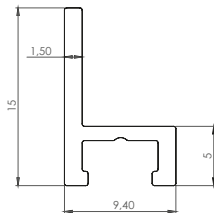

zaślepka do stopki cokołowej
assembly set



symbol nr	kolor
symbol code	color
51205000	naturalne aluminium natural aluminium

symbol nr	kolor
symbol code	color
51205100	szary grey

AMS – Aluminiowe Moduły Systemowe do budowy regałów AMS shelving aluminium modular system



więcej przestrzeni, dowolność aranżacji | more space, custom arrangement



profil pionowy podstawowy basic vertical profile

AMS 31706000

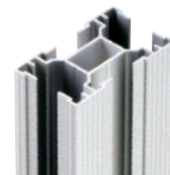
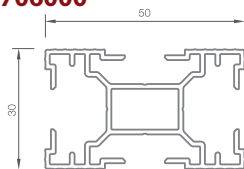

symbol nr	kolor	przekrój	długość	jedn. waga	gr. wypełnienia	pakowanie	waga wiązki
symbol code	color	cross-section	length	weight	thickness	packing	bundle
AMS 31706000	naturalne aluminium natural aluminium	30 x 50 mm	3 m	2,27 kg/szt.	6 8 10 mm	wiązka 6 szt. 6 pcs bundle	14 kg

profil pionowy AMS SLEEK basic vertical profile

AMS 31736000

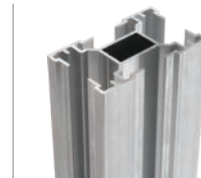
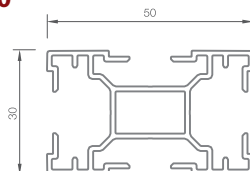

symbol nr	kolor	przekrój	długość	jedn. waga	gr. wypełnienia	pakowanie	waga wiązki
symbol code	color	cross-section	length	weight	thickness	packing	bundle
AMS 1736	naturalne aluminium natural aluminium	30 x 50 mm	3 m	2,27 kg/szt.	6 8 10 mm	wiązka 6 szt. 6 pcs bundle	14 kg

profil pionowy alter alter vertical profile

AMS 31724000

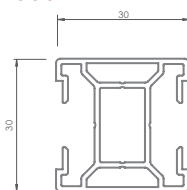

symbol nr	kolor	przekrój	długość	jedn. waga	gr. wypełnienia	pakowanie	waga wiązki
symbol code	color	cross-section	length	weight	thickness	packing	bundle
AMS 31724000	naturalne aluminium natural aluminium	30 x 30 mm	3 m	1,70 kg/szt.	szkło płyta glass board	wiązka 5 szt. 5 pcs bundle	6 kg

wypełnienie półokrągłe semicircular filling

AMS 31703000

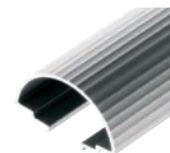
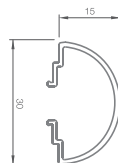
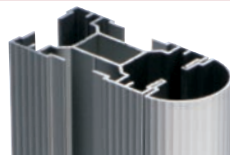

symbol nr	kolor	przekrój	długość	jedn. waga	pakowanie	waga wiązki
symbol code	color	cross-section	length	weight	packing	bundle
AMS 31703000	naturalne aluminium natural aluminium	30 x 15 mm	3 m	0,58 kg/szt.	wiązka 4 szt. 4 pcs bundle	2,3 kg

wypełnienie płaskie flat filling

AMS 31705000

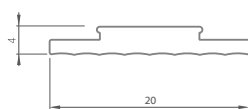

symbol nr	kolor	przekrój	długość	jedn. waga	pakowanie	waga wiązki
symbol code	color	cross-section	length	weight	packing	bundle
AMS 31705000	naturalne aluminium natural aluminium	20 x 4 mm	3 m	0,33 kg/szt.	wiązka 10 szt. 10 pcs bundle	3,3 kg



wypełnienie płaskie SLEEK
flat filling

AMS 31741000

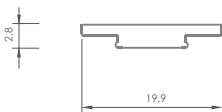

symbol nr	kolor	przekrój	długość	jedn. waga	pakowanie	waga wiązki
symbol code	color	cross-section	length	weight	packing	bundle
AMS 31741000	naturalne aluminium natural aluminium	20 x 2,5 mm	3 m	0,49 kg/szt.	wiązka 10 szt. 10 pcs bundle	4,9 kg

wypełnienie
filling

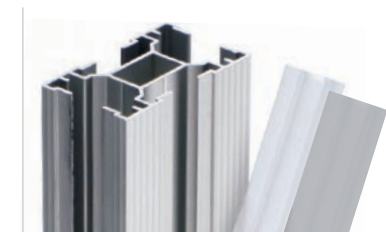

AMS 31716000
wypełnienie giętkie przezroczyste
flexible transparent filing

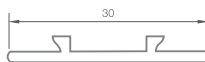

AMS 31720000
wypełnienie giętkie szare
flexible grey filing

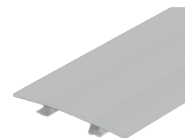
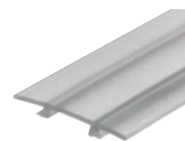

symbol nr	kolor	przekrój	długość	jedn. waga	pakowanie	waga wiązki
symbol code	color	cross-section	length	weight	packing	bundle
AMS 31716000	przezroczyste / transparent	30 x 4 mm	3 m	0,01 kg/szt.	50 m	0,5 kg
AMS 31720000	szare / grey					

mocowanie półki z płyty
board shelf fastening

AMS 31707000

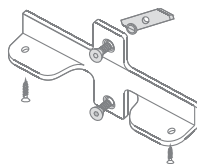

symbol nr	kolor	wypełnienie	jedn. waga	pakowanie
symbol code	color	filing	weight	packing
AMS 31707000	naturalne aluminium natural aluminium	plyta board	0,24 kg/kpl	kpl 2 szt. 2 pcs set

mocowanie półki z płyty 300 mm
board shelf fastening 300 mm

AMS 31742100

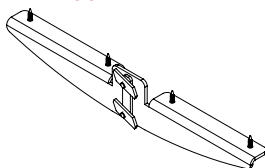

symbol nr	kolor	wypełnienie	jedn. waga	pakowanie
symbol code	color	filing	weight	packing
AMS 31742100	naturalne aluminium natural aluminium	plyta board	0,64 kg/kpl	kpl 2 szt. 2 pcs set



mocowanie półki szklanej
glass shelf fastening

AMS 31708000

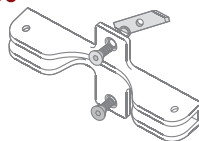

symbol nr symbol code	kolor color	wypełnienie filing	gr. wypełnienia thickness	jedn. waga weight	pakowanie packing
AMS 31708000	naturalne aluminium natural aluminium	szkło glass	6 8 10 mm	0,30 kg/kpl	kpl 2 szt. 2 pcs set

mocowanie półki pod kątem
boots shelf fastening

AMS 31725000

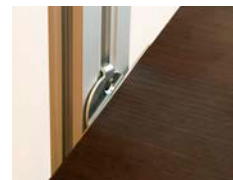
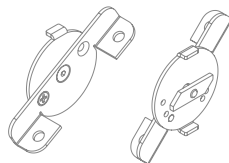

symbol nr symbol code	kolor color	wypełnienie filing	pakowanie packing
AMS 31725000	naturalne aluminium natural aluminium	plyta board	kpl 2 szt. 2 pcs set

uchwyt na półkę z płyty ALTER
board shelf fastening

AMS 31731000

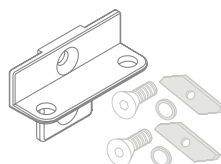

symbol nr symbol code	kolor color	wypełnienie filing	pakowanie packing
AMS 31731000	naturalne aluminium natural aluminium	plyta board	kpl 2 szt. 2 pcs set

uchwyt na półkę ze szkła ALTER
glass shelf fastening

AMS 31732000

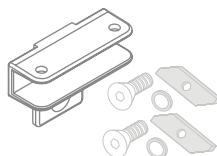

symbol nr symbol code	kolor color	wypełnienie filing	pakowanie packing
AMS 31732000	naturalne aluminium natural aluminium	szkło glass	kpl 2 szt. 2 pcs set

uchwyt na szafkę ALTER
cabinet fastening

AMS 31733000

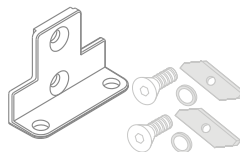

symbol nr symbol code	kolor color	wypełnienie filing	pakowanie packing
AMS 31733000	naturalne aluminium natural aluminium	plyta board	kpl 2 szt. 2 pcs set



mocowanie kątowe płyty
board fastening vertical / horizontal

AMS 31717000

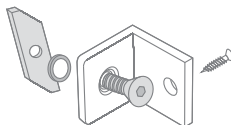

symbol nr symbol code	kolor color	wypełnienie filling	pakowanie packing
AMS 31717000	naturalne aluminium natural aluminium	plyta board	kpl 1 szt. 1 pcs set

mocowanie półki kasetonowej
lighting box shelf fastening

AMS 31721000

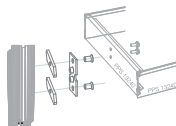

symbol nr symbol code	kolor color	wypełnienie filling	pakowanie packing
AMS 31721000	stal steel		kpl 2 szt. 2 pcs set

mocowanie do ściany i sufitu
wall and ceiling fastening

AMS 31709000



symbol nr symbol code	kolor color	wypełnienie filling	pakowanie packing
AMS 31716000	naturalne aluminium natural aluminium		kpl 1 szt. 1 pcs set

mocowanie do podłogi
floor fastening

AMS 31710000

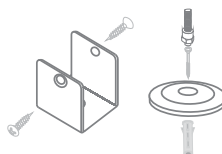

symbol nr symbol code	kolor color	wypełnienie filling	pakowanie packing
AMS 31710000	naturalne aluminium natural aluminium		kpl 1 szt. 1 pcs set

drążek ubraniowy z uszczelką
aluminium clothing bar with seal

AMS 31742000

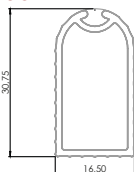

symbol nr symbol code	kolor color	przekrój cross-section	długość length	jedn. waga weight	pakowanie packing
AMS 31742000	naturalne aluminium natural aluminium	30,75 x 16,50 mm	3 m	0,81 kg szt. pc	wiązka 5 szt. 5 pcs bundle



drażek SLEEK LED
aluminium clothing bar

AMS 31737000

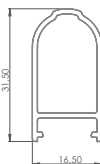

symbol nr	kolor	przekrój	długość	jedn. waga	pakowanie
symbol code	color	cross-section	length	weight	packing
AMS 31737000	naturalne aluminium natural aluminium	30 x 15 mm	3 m	0,88 kg szt. pc	wiązka 5 szt. 5 pcs bundle

mocowanie drążka na SLEEK LED
clothing bar fastening

AMS 31739000

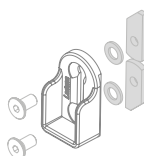

symbol nr	kolor	pakowanie
symbol code	color	packing
AMS 31739000	naturalne aluminium natural aluminium	kpl 2 szt. 2 pcs set

profil rura Ø 25
pipe profile Ø 25

AMS 31715000

zastosowanie: • rozporowa - stabilizująca konstrukcję
• poprzeczka wieszak

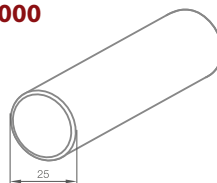

symbol nr	kolor	przekrój	długość	waga	pakowanie	waga wiązki
symbol code	color	cross-section	length	weight	packing	bundle
AMS 31715000	naturalne aluminium natural aluminium	25 mm	3 m	0,90 kg/szt.	wiązka 2 szt. 2 pcs bundle	2 kg

mocowanie rury do profilu
pipe fastening to profile

AMS 31711000

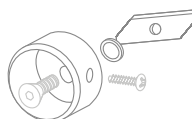

symbol nr	kolor	pakowanie	waga wiązki
symbol code	color	packing	bundle
AMS 31711000	naturalne aluminium natural aluminium	kpl 1szt. 2 pcs set	0,04 kg/szt.

mocowanie rury do ściany
pipe fastening to wall

AMS 31712000

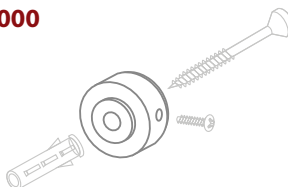

symbol nr	kolor	pakowanie	waga wiązki
symbol code	color	packing	bundle
AMS 31712000	naturalne aluminium natural aluminium	kpl 1szt. 1 pcs set	0,34 kg/szt.



połączenie kątowe aluminium
aluminium angle connection

AMS 31713000

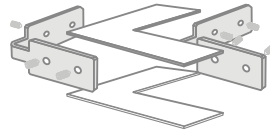

symbol nr	kolor	pakowanie	waga wiązki
symbol code	color	packing	bundle
AMS 31713000	naturalne aluminium natural aluminium	kpl 1 szt. 1 pcs set	0,23 kg/szt.

połączenie kątowe tworzywo
plastic angle connection

AMS 31719000



symbol nr	kolor	pakowanie	waga wiązki
symbol code	color	packing	bundle
AMS 31719000	naturalne aluminium natural aluminium	kpl 1 szt. 1 pcs set	0,23 kg/szt.

połączenie proste
straight connector

AMS 31714000

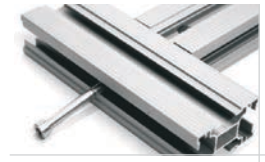

symbol nr	kolor	pakowanie	waga wiązki
symbol code	color	packing	bundle
AMS 31714000	naturalne aluminium natural aluminium	kpl 1 szt. 1 pcs set	0,03 kg/szt.

zaślepka do profilu 1724 ALTER
hole plug for 1724 ALTER

31729000

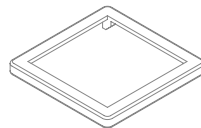
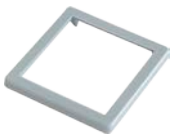

zaślepka do profilu 1706 AMS
hole plug for 1706 AMS

31730000

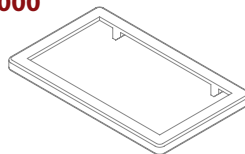



opaska mocująca do profilu 1724 AMS
covering band for 1724 AMS

31738000

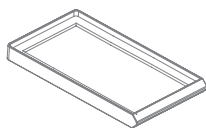

opaska mocująca do profilu 1706 AMS
covering band for 1706 AMS

31722000

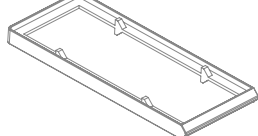

uszczelka U-10
seal U-10

98818000

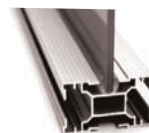
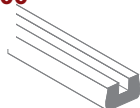
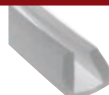

uszczelka U-16
seal U-16

98815000

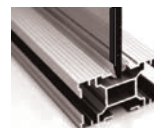
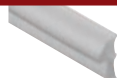

symbol	nr	kolor*	grubość szkła	jedn. waga	pakowanie	waga wiązki	* informacje dodatkowe
symbol	code	color*	glass thickness	weight	packing	bundle	*additional informations
U 16	98815000	przezroczyste transparent	6 mm	0,04 kg/m	50 m	2 4 kg	* dostępne także inne kolory oraz wykończenia powierzchni other colours and surface types available
U 10	98818000		6 mm	0,04 kg/m	50 m	1 2 kg	* listwy dostępne w innych odcinkach (podział 5,5 m) profiles individually available in other length (divided 5,5 m)

pantograf
pantograph

AMS 31740000

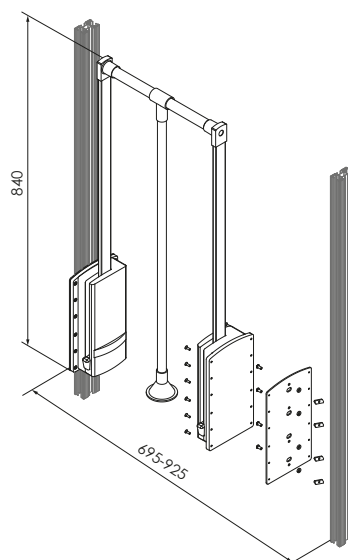

symbol nr	kolor	pakowanie
symbol code	color	packing
AMS 31740000	naturalne aluminium natural aluminium	kpl 1 szt. 1 pcs set

Wallglass - system aluminiowy Wallglass - aluminium system



podkreślenie charakteru każdej kuchni | highlight every kitchen style



profil WALLGLASS
profile WALLGLASS

51314500

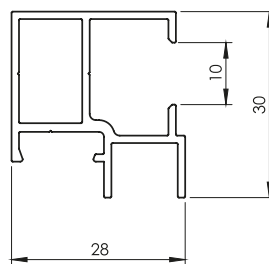

symbol nr symbol code	kolor color	przekrój cross-section	długość length
51314500	aluminium anodowane anodized aluminium	28 x 30 mm	4 m

połączenie kątowe
angle connection

31719000



symbol nr symbol code	kolor color	przekrój cross-section
31719000	aluminium anodowane anodized aluminium	28 x 30 mm

kątownik WALLGLASS
angle connection WALLGLASS

51720000



symbol nr symbol code	kolor color	przekrój cross-section
51720000	aluminium anodowane anodized aluminium	28 x 30 mm

wypełnienie płaskie SLEEK
flat filling SLEEK

31741000



symbol nr symbol code	kolor color	przekrój cross-section
31741000	aluminium anodowane anodized aluminium	28 x 30 mm

uszczelka U-10
seal U-10

98225000



symbol nr symbol code	kolor color	przekrój cross-section
98225000	bezbarna pure	30 x 30 mm

dyfuzor bezbarwny
transparent diffuser

51348100

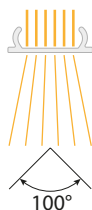

symbol nr symbol code	przekrój cross-section	materiał material	długość length	
51348100	~14 x 4 mm	PC	2 m	3 m
51348130		PVC	3 m	

dyfuzor bezbarwny
transparent diffuser

51348110



symbol nr symbol code	przekrój cross-section	materiał material	długość length
51348110	~14 x 8 mm	PC	3 m

RZESUWNY DO RAMEK
em for frames

STELAŻE MEBLOWE
furniture aluminium footing

anima domus

ul. Maszynowa 32 A

80-298 Gdańsk, POLAND

tel. +48 58 770 48 00 fax +48 58 743 57 01

www.animadomus.com.pl



INNOWACYJNA GOSPODARKA
NARODOWA STRATEGIA OPROGNOZI

UNIA EUROPEJSKA
EUROPEJSKI FUNDUSZ
ROZWOJU REGIONALNEGO



Fundusze Europejskie - dla rozwoju innowacyjnej gospodarki.
Inwestujemy w waszą przyszłość.

listwy i
LED slats